

GRUPPO NOSTRUM

DENTAL MARKET
design and manufacturing of dental articles

PLUSS 

PROGETTAZIONE E PRODUZIONE ARTICOLI DENTALI
DESIGN AND MANUFACTURING OF DENTAL ARTICLES





VERSIONE 2017

L'azienda, in ragione dei continui studi che effettua al fine di migliorare l'efficacia dei prodotti offerti, si riserva il diritto di modificare in qualunque momento e senza obbligo di preavviso i dati ed i dettagli tecnici relativi ai propri articoli



INDICE Linee

	Pag.
Articoli Monouso	15 - 43
Accessori	45 - 90
Porta Impronte	93 - 115
Strumenti Manico Liscio	117 - 133
Strumenti Manico Anatomico	135 - 154
Strumenti Manico Vuoto	157 - 173
Strumenti Manico Colorato Autoclavabile	175 - 191
Strumentario Chirurgico	193 - 221
Frese Diamantate	223 - 248

Categories INDEX

	Pag.
Disposable Articles	15 - 43
Accessories	45 - 90
Impression Trays	93 - 115
Instruments With Smooth Handle	117 - 133
Instruments With Anatomic Handle	135 - 154
Instruments With Empty Handle	157 - 173
Instruments With Coloured Handle	175 - 191
Surgical Instruments	193 - 221
Diamond Burs	223 - 248

A			
Articolatori.....	65	Pinze per estrazione.....	214-220
Aspirasaliva.....	16-19	Pinze per frammenti.....	213-214
Aspirasaliva estremità angolare.....	23	Pinzette per medicazione.....	196
		Pinzette porta lastrine.....	65
B		Porta aghi.....	200-203
Bacinella reniforme in acciaio.....	81	Porta amalgama.....	68
Bacinella reniforme monouso.....	31	Porta bicchieri.....	48
Base per punte sindesmotomo.....	70	Porta bite.....	55
Bicchierini monouso.....	41	Porta cotone in alluminio.....	85
Blocchetti per impasto.....	39-40	Porta frese.....	70-71
Buste per sterilizzazione.....	39	Porta lastrine.....	65
		Porta matrici.....	220-221
C		Porta palline di cotone.....	49
Cannule aspira saliva.....	16-19	Porta protesi.....	55
Cannule Aspirasaliva estremità angolare.....	23	Porta rifiuti in alluminio.....	85
Cassette inox per sterilizzazione.....	82-83	Porta rifiuti monouso.....	35
Catene per salviette.....	22-23	Porta vassoi.....	78-79
Combinazione sonde/sonde millimetriche manico anatomico.....	141	Porta strumenti canalari.....	70
Combinazione sonde/sonde millimetriche manico colorato.....	181	Portaimpronte alluminio.....	106-107
Combinazione sonde/sonde millimetriche manico liscio.....	123	Portaimpronte edentuli.....	110-113
Combinazione sonde/sonde millimetriche manico vuoto.....	163	Portaimpronte inox.....	90-101
Contentori per endodonzia.....	56-64	Portaimpronte monouso.....	115
Copriscarpe.....	41	Portaimpronte policarbonato.....	113-114
Copritestiera.....	36	Portaimpronte rylsan.....	108-109
Curette manico anatomico.....	153	Pozzetto monouso.....	31
Curette manico colorato.....	191	Pulitori per strumenti canalari.....	66
Cucchiai alveolari manico anatomico.....	154	Puntale monouso aria/acqua.....	25
		R	
D		Rastrelliere porta strumenti in alluminio.....	77-78
Dappen monouso.....	40	Rastrelliere porta strumenti in acciaio.....	79-80
Distributori di bicchieri.....	48	Rotoli per sterilizzazione.....	38
Distributori di cannule aspirasaliva.....	50	Rulli salivari.....	37
Distributore di mantelline.....	51		
Distributori di mascherine.....	50	S	
Distributore di palline di cotone.....	49	Salviette monouso.....	20
Distributore di rulli.....	52-53	Scatola porta frese.....	72
Distributore di salviette.....	51	Scatole porta protesi.....	55
Divaricatori.....	195	Scatolina porta aghi usati.....	33
		Scollaperiostio.....	196
E		Seklip.....	25
Endobox.....	56-64	Siringe per amalgama.....	69
Escavatori manico anatomico.....	152	Sonde manico anatomico.....	136-137
Escavatori manico colorato.....	190	Sonde manico colorato.....	176-178
Escavatori manico liscio.....	133	Sonde manico liscio.....	118-119
Escavatori manico vuoto.....	173	Sonde manico vuoto.....	158-159
		Sonde millimetriche manico anatomico.....	138-140
F		Sonde millimetriche manico colorato.....	179-180
Forbici.....	198-200	Sonde millimetriche manico liscio.....	120-122
Frese diamantate.....	223-248	Sonde millimetriche manico vuoto.....	160-162
		Sovrascarpe.....	41
G		Spatole flessibili.....	47
Ghiaccio istantaneo.....	38	Spatole heidemann manico anatomico.....	144
Guanti monouso.....	43	Spatole heidemann manico colorato.....	184
		Spatole heidemann manico liscio.....	126
I		Spatole heidemann manico vuoto.....	166
Inseriti per cassette.....	84	Spatole per cementi manico anatomico.....	145
Inseriti per supporti.....	90	Spatolina monouso per impasto.....	31
Interni porta frese.....	72	Spazzolini monouso.....	26
K		Specchietti per bocca.....	194
Kit monouso per esame.....	26	Spugnette per endodonzia.....	68
Kit per implantologia.....	87-89	Strumenti per otturazioni plastiche manico anatomico.....	149-151
		Strumenti per otturazioni plastiche manico colorato.....	187-189
L		Strumenti per otturazioni plastiche manico liscio.....	130-132
Leve per radici.....	207-213	Strumenti per otturazioni plastiche manico vuoto.....	170-172
		Strumenti per trattamenti canalari manico anatomico.....	142-143
M		Strumenti per trattamenti canalari manico colorato.....	182-183
Manici per bisturi.....	197	Strumenti per trattamenti canalari manico liscio.....	124-125
Manici per specchietti.....	194	Strumenti per trattamenti canalari manico vuoto.....	164-165
Mantelline monouso.....	24	Supporto porta rifiuti.....	35
Mascherine chirurgiche.....	27	Supporto universale.....	69-86
Micro applicatori.....	25		
Misuratori per strumenti canalari.....	65-66	T	
		Tazze per alginato e gesso.....	46
O		Teli sterili monouso.....	42
Ominitray per disinfezione.....	53	Tray acciaio inox.....	77-80
Orthobox.....	54	Tray alluminio.....	73-76
Otturatori manico anatomico.....	146-148	Tray per endodonzia.....	64
Otturatori manico colorato.....	185-186	Tray paper.....	35
Otturatori manico liscio.....	127-129		
Otturatori manico vuoto.....	167-169	V	
		Vaschette inox.....	80
P		Vaschette monouso.....	30
Palline di cotone.....	37	Vassoi in acciaio inox.....	77-80
Perni calcinabili.....	32	Vassoi in alluminio anodizzato.....	73-76
Piastra millimetrata.....	142	Vassoi monouso.....	28-31
Piastrine porta frese.....	70	Visiera protettiva monouso.....	33-34
Pinze emostatiche.....	204-205		
Pinze ossivore.....	205-207		

- A**
- Aluminium tray 73-76
 - Aveolar spoon with anatomic handle 154
 - Amalgam gun 69
 - Amalgam well 68
 - Aspirating tube 45° 23
 - Articulator 65
- B**
- Basin, disposable 30
 - Bibs, disposable 24
 - Bibs, dispenser 51
 - Bibs hders 22-23
 - Bistouri handle 197
 - Bones forceps 205-207
 - Box for bite 55
 - Box for implantology 87-89
 - Box for mill holder 72
 - Box for prothesis 55
 - Box for sterilization, stainless steel 82-83
 - Box used needles 33
 - Brushes, disposable 26
- C**
- Calcinable pins 32
 - Canal instrument holder 70
 - Clips for radiographs 65
 - Combination explorers probes with anatomic handle 141
 - Combination explorers probes with coloured handle 181
 - Combination explorers probes with empty handle 163
 - Combination explorers probes with smooth handle 123
 - Complete denture impression trays 110-113
 - Cotton dispenser, aluminium 85
 - Cotton pellet dispenser 49
 - Cotton pellets, disposable 37
 - Cotton rolls, disposable 37
 - Cotton rolls, dispenser 52-53
 - Cups, disposable 41
 - Curettes with anatomic handle 153
 - Curettes with coloured handle 191
- D**
- Dappen, disposable 40
 - Diamond burs 223-248
 - Dispenser, bibs 51
 - Dispenser, cotton pellet 49
 - Dispenser, cotton rolls 52-53
 - Dispenser, drinking cup 48
 - Dispenser, saliva ejectors 50
 - Dispenser, surgical masks 50
 - Dispenser, towels 51
 - Dressing tweezers 196
- E**
- Endodontic instruments cleaner 67
 - Endodontic instruments with anatomic handle 142-143
 - Endodontic instruments with empty handle 164-165
 - Endodontic instruments with coloured handle 182-183
 - Endodontic instruments with smooth handle 124-125
 - Endodontic box 56-64
 - Endodontic tray 64
 - Endome ter 65-66
 - Excavator with anatomic handle 152
 - Excavator with coloured handle 190
 - Excavator with empty handle 173
 - Excavator with smooth handle 133
 - Examination kit, disposable 26
 - Explorers with anatomic handle 136-137
 - Explorers with coloured handle 176-178
 - Explorers with empty handle 158-159
 - Explorers with smooth handle 118-119
- F**
- Filling instruments with anatomic handle 146-148
 - Filling instruments with coloured handle 185-186
 - Filling instruments with empty handle 167-169
 - Filling instruments with smooth handle 127-129
 - Flexible spatula 47
 - Forceps for extractions 214-220
 - Frame, aluminium 77-78
 - Frame, stainless steel 79-80
- G**
- Glasses, disposable 34
 - Gloves, disposable 43
- H**
- Haemostatic forceps 204-205
 - Handles for mirrors 194
 - Headrest covers 36
 - Heidemann separating spatula with anatomic handle 144
 - Heidemann separating spatula with coloured handle 184
 - Heidemann separating spatula with empty handle 166
 - Heidemann separating spatula with smooth handle 126
- I**
- Ice, disposable 38
 - Impression trays, aluminium 106-107
 - Impression trays, complete denture 110-113
 - Impression trays, disposable 115
 - Impression trays, polycarbonate 113-114
 - Impression trays, rylsan 108-109
 - Impression trays, stainless steel 90-101
 - Inserts for stainless steel boxes 84
 - Inserts for universal supports 90
 - Inserts frames, aluminium 77-78
 - Inserts frames, stainless steel 79-80
 - Inserts trays for box for mill 72
- K**
- Kidney trays, disposable 31
 - Kidney trays, stainless steel 81
- L**
- Low mill holder 70
- M**
- Matrix retainers 220-221
 - Measuring plate 142
 - Micro applicator 25
 - Mill holder 70-72
 - Mixing bowls for plaster and alginates 46
 - Mixing pad 39-40
 - Mirrors for mouth 194
 - Mixing pallet, disposable 31
- N**
- Napkins, disposable 20
 - Needle holders 200-203
- O**
- Omnitray for disinfection 53
 - Orthbox 54
- P**
- Periodontal pocket probes with anatomic handle 138-140
 - Periodontal pocket probes with coloured handle 179-180
 - Periodontal pocket probes with empty handle 160-162
 - Periodontal pocket probes with smooth handle 120-122
 - Periosteal elevator 196
 - Plastic filling instruments with anatomic handle 149-151
 - Plastic filling instruments with coloured handle 187-189
 - Plastic filling instruments with empty handle 170-172
 - Plastic filling instruments with smooth handle 130-132
- R**
- Retrator 195
 - Roots elevator 207-213
 - Root fragments forceps 213-214
- S**
- Saliva ejectors, disposable 16-19
 - Saliva ejectors, dispenser 50
 - Scissors 198-200
 - Sekutip 25
 - Shoe covers 41
 - Syndesmotome tips holder 70
 - Spatula, flexible 47
 - Spatula, disposable 31
 - Spatula for cement with anatomic handle 145
 - Sponges for endodontic, disposable 68
 - Sterile drapes, disposable 42
 - Sterilization flat reels, disposable 38
 - Sterilization self seal pouches, disposable 39
 - Surgical masks 27
 - Surgical masks, dispenser 50
 - Support for waste receiver 35
- T**
- Tip for air/water syringe (disposable) 25
 - Towels, disposable 20
 - Towels, dispenser 51
 - Tray paper 35
 - Tray rack 78-79
 - Trays, aluminium 73-76
 - Trays, disposable 28-31
 - Trays, stainless steel 77-80
 - Tweezers, dressing 196
- U**
- Universal support 86
- V**
- Protective shield, disposable 33-34
- W**
- Waste container, aluminium 85
 - Waste receiver, disposable 35

L'AZIENDA



DENTAL MARKET srl è un'azienda di produzione e vendita di articoli odontoiatrici per studio dentale, presente sul mercato nazionale ed internazionale da circa 40 anni, realtà solida e ben radicata.

L'azienda fa parte di un gruppo nato nel 1923, "Gruppo Nostrum" che ad oggi opera in diversi settori, oltre a quello della produzione di articoli dentali.

Dental Market nasce come azienda terzista, specializzata nella produzione di articoli in acciaio inox ed alluminio e diventa oggi un'azienda poliedrica, capace di produrre come terzista, personalizzando totalmente il prodotto, ma capace di introdurre, sia nel mercato nazionale che internazionale, il nuovo marchio PLUSS, marchio privato di DENTAL MARKET.

Nel corso degli anni l'azienda si è sempre più specializzata nella produzione di articoli in alluminio ed acciaio, tra cui spiccano le porta impronte, lo strumentario, tutta la linea di vassoi e di box endodontici, completamente Made in Italy, eseguiti interamente nei nostri stabili in Toscana.

THE COMPANY



DENTAL MARKET srl is a company of manufacturing and sale of dental products for dental office, presents on the national and international market for about 40 years, solid and well rooted reality.

The company is part of a group born in 1923, "Group Nostrum" which now operates in various sectors, more than the production of dental articles.

Dental Market began its work as a contractor, specialized in the production of stainless steel and aluminum articles and it becomes today a versatile reality, able to produce as a subcontractor, totally personalizing the product, but also able to introduce, in both national and international market, the new PLUSS brand, private label of DENTAL MARKET.

Over the years the company increasingly specialized itself in the production of aluminum and stainless steel articles, as impression trays, surgical instruments, the whole line of trays and endodontic boxes, entirely Made in Italy, completely produced in our facilities in Tuscany.



Dental Market è riuscita nel contempo a sviluppare una vasta esperienza nella produzione di stampaggio di materie plastiche e produzione di articoli monouso, tra cui spiccano i due articoli di punta, le **cannule aspira saliva monouso e le salviette monouso**, prodotte con macchinari di avanguardia nei nostri stabilimenti in Toscana, con livelli qualitativi e produttivi altissimi.

Alla base di queste produzioni esistono una solida esperienza e studi continui, che hanno portato a costanti miglioramenti ed innovazioni nei prodotti. Gli articoli DENTAL MARKET garantiscono la qualità del prodotto MADE IN ITALY, abbinando scelta di buone materie prime e proponendosi sempre con prezzi concorrenziali.



Dental Market has succeeded at the same time to develop a wide experience in manufacturing of plastic and disposable articles, where we can find the production of the two leading articles, **disposable saliva ejectors** and **disposable towels**, produced with modern machinery in our facilities in Tuscany, with the highest levels of quality and productivity.

At the basis of these productions exist a solid experience and continuous studies, which bring constant improvements and innovations in products.

DENTAL MARKET articles ensure MADE IN ITALY products quality, combining choice of good raw materials and always presenting itself with competitive prices.



La nostra filosofia produttiva si basa su concetti oggi distanti dal difficile mercato internazionale: lavorare sullo stock del nostro magazzino. I nostri programmi di produzione si basano su grandi lotti produttivi, in modo da risparmiare al massimo sui costi di produzione, ottimizzare i costi aziendali ed importantissimo, avere tutti i pezzi sempre in stock pronti per la spedizione. Il nostro magazzino è organizzato per spedire l'ordine in pochi giorni, evitando così ai nostri clienti l'onere di fare magazzino a loro volta.

La nostra forza sta nel poter soddisfare ogni esigenza dei nostri clienti, sia per quanto riguarda le spedizioni, sia per le personalizzazioni del packaging, sia per lo sviluppo di nuovi prodotti.

Il nostro vario parco macchine ci permette di poter sviluppare eventuali nuovi progetti, producendo nuovi articoli in esclusiva per i nostri clienti.

Offriamo inoltre la totale personalizzazione del prodotto, sia da un punto di vista di packaging, sia con marchiatura del prodotto con logo privato.

In un mercato in rapida evoluzione Dental Market considera le norme ISO e la marcatura CE punto di riferimenti per la qualità dei suoi prodotti. L'azienda infatti rinnova annualmente le proprie certificazioni ISO 9001 e ISO 13485 e la certificazione CE dei suoi dispositivi medici.

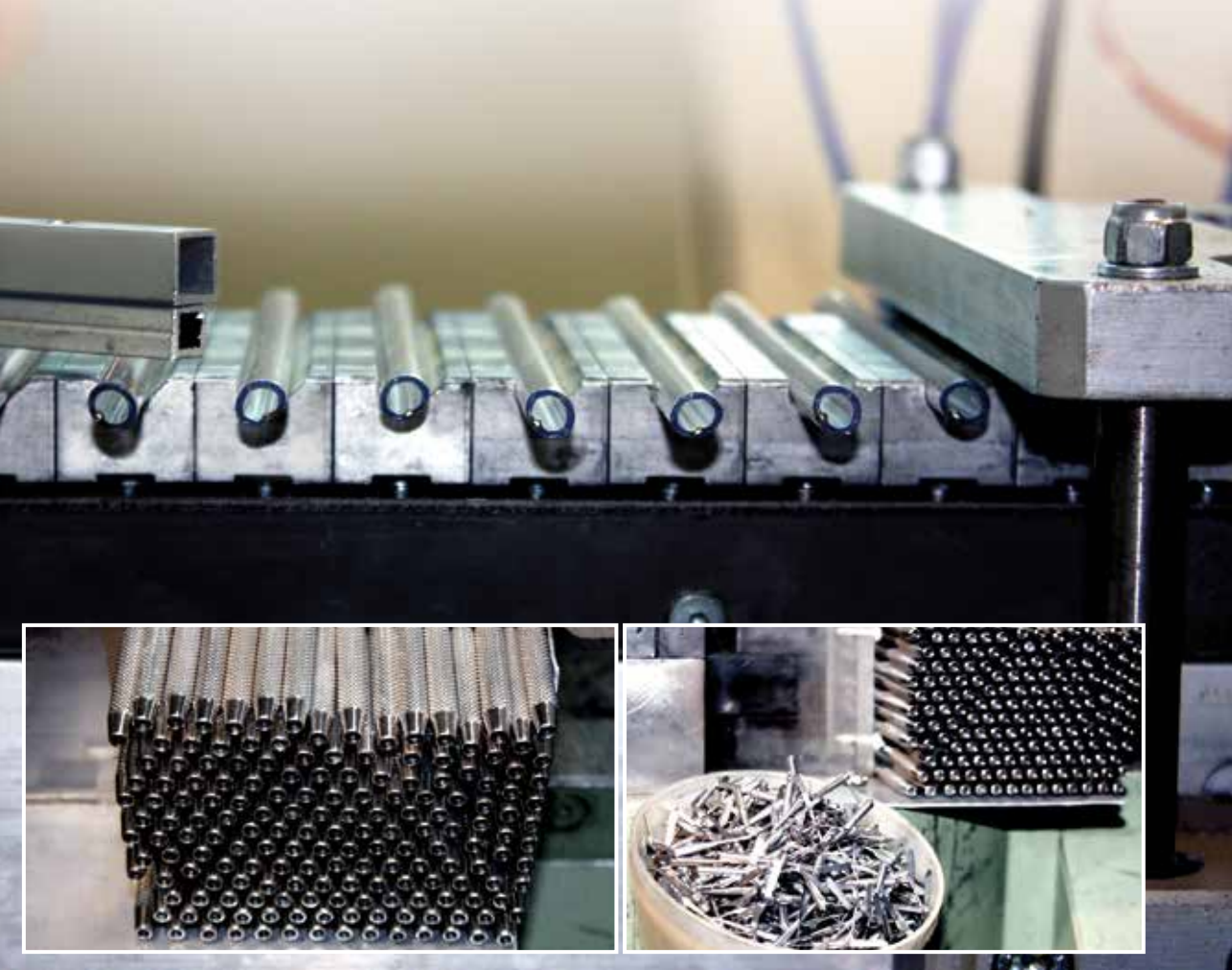

Our production philosophy is based on concepts far from the current difficult international market: working on the stock of our warehouse. Our production plans are based on large production batches, in order to save at most on production costs, optimizing work costs and most important, to have all the articles always in stock ready to be shipped.

Our warehouse is organized to ship the order within few days, thus avoiding our customers the burden of making stock themselves.

Our strength is that we are able to meet every need of our customers, whether in terms of shipments, or for the personalization of packaging and for the development of new products.

Our diverse machineries allow us to develop new projects, producing new items exclusively for our customers.

We also offer total personalization of the product, whether from the point of view of packaging and with marking of the product with private logo.

In a rapidly changing market Dental Market considers the ISO and CE marking point of reference for the quality of its products. The company in fact renews annually ISO 9001 and ISO 13485 and CE certification of its medical devices.



MONOUSO
DISPOSABLE ARTICLES

CANNULE ASPIRASALIVA MONOUSO con cappuccio removibile

*Disposable saliva ejectors
with removable tip*



- Made in Italy e certificate in Classe IIa
- Aromatizzate alla vaniglia
- Il cappuccio removibile è studiato per essere ben saldo sul tubo
- Vengono utilizzate materie prima di ottima qualità, totalmente atossiche
- **PRIMO BREVETTO:** il filo ramato all'interno del tubo è fermato senza uso di collanti. Ne consegue un prodotto unico e completamente **atossico**.
- **SECONDO BREVETTO:** la busta da 100 pezzi è confezionata con una fascetta di sicurezza che garantisce **qualità e risparmio nei costi di trasporto**
- **TERZO BREVETTO:** applichiamo un processo di decontaminazione di ogni singolo pezzo, per offrire **cannule decontaminate**, uniche sul mercato internazionale.
- *Made in Italy and Medical Device in Class II*
- *Slightly vanilla flavored,*
- *The removable tip is designed to have a great resistance on the tube*
- *Use of high quality raw materials, totally non-toxic*
- **FIRST PATENT:** the copper-coated wire inside the tube is stopped without use of any glue. We achieve a unique and **completely non-toxic** product.
- **SECOND PATENT:** the bag of 100 pieces is externally wrapped by a safety seal, as a guarantee of **quality and a huge saving on money on transport costs**
- **THIRD PATENT:** every piece is sanitised during the production process, it enabling us to offer the **first sanitary disposable saliva ejectors** on the global market

CANNULE ASPIRASALIVA MONOUSO con cappuccio fisso

*Disposable saliva ejectors
with fixed tip*





THE FIRST **UNCONTAMINATED** DISPOSABLE SALIVA EJECTOR



a brand of:



PROPERTY PATENT

Every piece is sanitised during the production process: it enabling us to offer **THE FIRST SANITARY DISPOSABLE SALIVA EJECTOR ON THE GLOBAL MARKET.**

CANNULE ASPIRASALIVA

Saliva ejectors

CANNULE ASPIRASALIVA CORTE

Short saliva ejectors

COLORI DISPONIBILI

Available colours

Trasparente / transparent

Azzurro / blue

Blu / dark blue

Verde / green

Verde chiaro / fresh green

Giallo / yellow

Arancione / orange

Rosso / red

Rosa / pink

Lilla / lilac

Fucsia / fuchsia

Bianco opaco / opaque white

Verde opaco / opaque green

Azzurro opaco / opaque blue

BOX 5000 PCS

PACK 100 PCS

TD3400/1

TD3400/TAZ1

TD3400/TB1

TD3400/TV1

TD3400/TVC1

TD3400/TG1

TD3400/TA1

TD3400/TR1

TD3400/TRA1

TD3400/TL1

TD3400/TF1

TD3400/OB1

TD3400/OV1

TD3400/OAZ1

BOX 5000 PCS

PACK 250 PCS

TD3400/2

TD3400/TAZ2

TD3400/TB2

TD3400/TV2

TD3400/TVC2

TD3400/TG2

TD3400/TA2

TD3400/TR2

TD3400/TRA2

TD3400/TL2

TD3400/TF2

TD3400/OB2

TD3400/OV2

TD3400/OAZ2

BOX 1000 PCS

PACK 100 PCS

TD3400/1MIL

TD3400/TAZ1MIL

TD3400/TB1MIL

TD3400/TV1MIL

TD3400/TVC1MIL

TD3400/TG1MIL

TD3400/TA1MIL

TD3400/TR1MIL

TD3400/TRA1MIL

TD3400/TL1MIL

TD3400/TF1MIL

TD3400/OB1MIL

TD3400/OV1MIL

TD3400/OAZ1MIL

CANNULE ASPIRASALIVA LUNGHE

Long saliva ejectors

COLORI DISPONIBILI

Available colours

Trasparente / transparent

Azzurro / blue

Blu / dark blue

Verde / green

Verde chiaro / fresh green

Giallo / yellow

Arancione / orange

Rosso / red

Rosa / pink

Lilla / lilac

Fucsia / fuchsia

Bianco opaco / opaque white

Verde opaco / opaque green

Azzurro opaco / opaque blue

BOX 5000 PCS

PACK 100 PCS

TD3410/1

TD3410/TAZ1

TD3410/TB1

TD3410/TV1

TD3410/TVC1

TD3410/TG1

TD3410/TA1

TD3410/TR1

TD3410/TRA1

TD3410/TL1

TD3410/TF1

TD3410/OB1

TD3410/OV1

TD3410/OAZ1

BOX 5000 PCS

PACK 250 PCS

TD3410/2

TD3410/TAZ2

TD3410/TB2

TD3410/TV2

TD3410/TVC2

TD3410/TG2

TD3410/TA2

TD3410/TR2

TD3410/TRA2

TD3410/TL2

TD3410/TF2

TD3410/OB2

TD3410/OV2

TD3410/OAZ2

BOX 1000 PCS

PACK 100 PCS

TD3410/1MIL

TD3410/TAZ1MIL

TD3410/TB1MIL

TD3410/TV1MIL

TD3410/TVC1MIL

TD3410/TG1MIL

TD3410/TA1MIL

TD3410/TR1MIL

TD3410/TRA1MIL

TD3410/TL1MIL

TD3410/TF1MIL

TD3410/OB1MIL

TD3410/OV1MIL

TD3410/OAZ1MIL

MORE IS LESS\$



A NEW IDEA.

A new way to stock, a better price per piece

The bag of 100 pieces is externally wrapped in a **safety seal**, as a guarantee of quality. It is an important additional feature for the sale to the dentist, because by placing a safety seal we guarantee that all quality checks have been done.

Moreover, it represents for dealers a huge saving of money on transport costs: the box is considerably smaller compared to the standard box. 1 pallet can be fitted with about 50% more goods, without any damage to the cartons on the first layers, with an obvious **saving on transport costs**.

a brand of:



SALVIETTE ASSORBENTI A 3 STRATI (2 veli carta + 1 PE)

*Disposable towels 3 plies
(2 plies paper+1 ply PE)*



TD0850



mis. 33x45 cm

BOX 500 PCS

TD0850AZZURRO *blue*
TD0850BIANCO *white*
TD0850GIALLO *yellow*
TD0850LILLA *lilac*

TD0850PESCA *pink peach*
TD0850ROSA *pink*
TD0850VERDE *green*

pink peach
pink
green

SALVIETTE ASSORBENTI A 2 STRATI (1 velo carta + 1 PE)

*Disposable towels 2 plies
(1 ply paper+1 ply PE)*



TD0851



mis. 33x45 cm

BOX 500 PCS

TD0851ARANCIONE *orange*
TD0851AZZURRO *blue*
TD0851BABYBLU *baby blue*
TD0851BABYROSA *baby pink*
TD0851BIANCO *white*
TD0851BLUNOTTE *dark blue*

TD0851FUCSIA *fuchsia*
TD0851LIME *lime*
TD0851MAGENTA *magenta*
TD0851SMERALDO *emerald green*
TD0851VERDE *green*

fuchsia
lime
magenta
emerald green
green



**NEW PACK
50 PCS**

**ALTA QUALITÀ
GRANDE ASSORBIMENTO
OTTIMA RESISTENZA AGLI STRAPPI**
**HIGH QUALITY GREAT
PAPER ABSORBENCY
PERFECT RESISTANCE**

WATER ONLY WHERE IT IS NEEDED



DISPOSABLE TOWELS

Dental Market produces these plasticised, folded, absorbent and impermeable TOWELS. High quality materials, great absorbency, perfect resistance are **THE BEST WAY TO PROTECT YOUR PATIENTS**

a brand of:  

CATENELLE PER SALVIETTE IN GOMMA STERILIZZABILE

Sterilizable rubber bibs holders

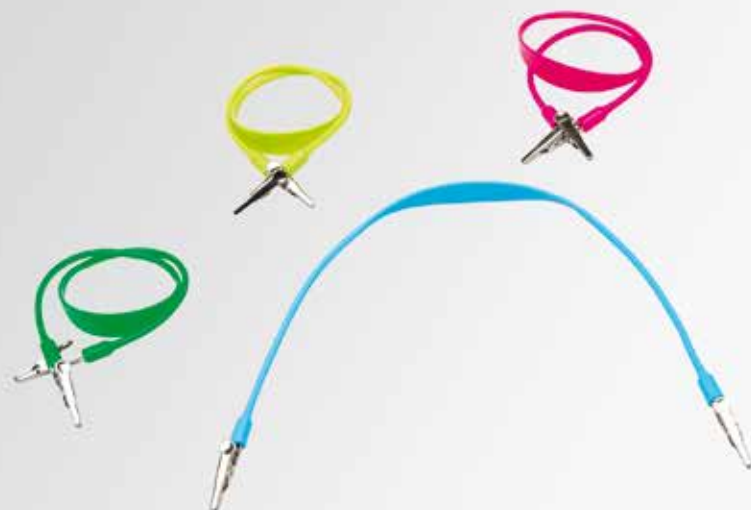

Profumate

Scented

TD0811 Kit 4 pcs

CATENELLE PER SALVIETTE MONOUSO

Disposable bibs holders



BOX 250 PCS

TD0820 adattabile, adesivo, igienico - adaptable, adhesive, hygienic

CATENELLE PER SALVIETTE

Bibs holders

TD0800 Top quality 1 pc
TD0805 Regular quality 1 pc

CANNULA ESTREMITÀ ANGOLARE 45°

*Disposable aspirating tube 45°
shaped end*

13 cm Ø 11 mm

PACK 100 PCS

TD3450 bianco - white

MANTELLINE IN ROTOLO A STRAPPO IN POLIETILENE

Polyethylene disposable bibs



48x60 cm 200 strappi

48x80 cm 200 strappi

TD0854BLU blu - blue
TD0854VERDE verde - green

TD0853BLU blu - blue
TD0853VERDE verde - green

Conf. da 6 rotoli - box 6 rolls

MANTELLINE IN ROTOLO A STRAPPO IN CARTA E POLIETILENE

*Polyethylene and paper
disposable bibs*



50x60 cm 80 strappi

50x80 cm 60 strappi

TD0855BIANCO white
TD0855BLU blue
TD0855VERDE green
TD0855ARANCIONE orange
TD0855BLUMED dark blue
TD0855LILLA lilac

TD0856BIANCO white
TD0856BLU blue
TD0856VERDE green
TD0856ARANCIONE orange
TD0856BLUMED dark blue
TD0856LILLA lilac

Conf. da 6 rotoli - box 6 rolls

Articoli monouso

DENTAL MARKET
design and manufacturing of dental articles

Disposable articles

SEKUTIP PUNTALI UNIVERSALI MONOUSO PER SIRINGHE ARIA/ACQUA

*Universal disposable tips
for air / water syringe*



BOX 300 PZ

TD0755ARANCIONE *orange*
TD0755AZZURRO *blue*
TD0755BIANCO *white*

TD0755GIALLO *yellow*
TD0755ROSA *pink*
TD0755VERDE *green*

MICRO APPLICATORI

Micro applicators



testa pieghevole

bendable neck

TD7100 *bianco - white*
TD7101 *giallo - yellow*
TD7102 *arancione - orange*
TD7103 *azzurro - blue*
TD7104 *lilla - lilac*
TD7105 *verde - green*

SUPERFINE
FINE
REGULAR
REGULAR
REGULAR
REGULAR



TD5253 Kit 3 pz. - Box 100 pz
TD5255 Kit 2 pz. - Box 200 pz

TD5250 specchietto monouso - *disposable mirror*
 Box 300 pz
TD5251 sonda monouso - *disposable probe*
 Box 300 pz
TD5252 pinzetta monouso - *disposable tweezers*
 Box 300 pz

SPAZZOLINI MONOUSO CON DENTIFRICIO

*Disposable mixed brushes
 with toothpaste*

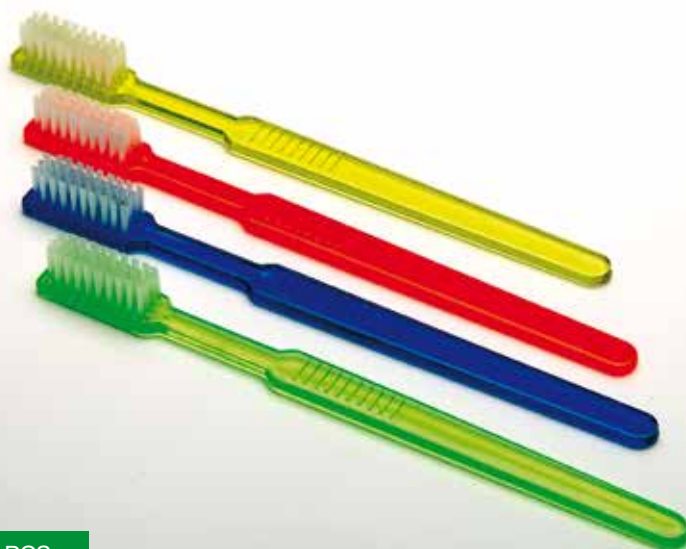

BOX 100 PCS

TD7028 spazzolini monouso misti verde, blu, arancione, giallo
disposable brushes mixed colours green, blue, orange, yellow

MASCHERINE CHIRURGICHE SUPERFILTRANTI CON ELASTICO

Earloop surgical masks



BOX 50 PCS

TD7030 Azzurro - *light blue*
TD7031 Verde - *green*
TD7032 Rosa - *pink*
TD7033 Giallo - *yellow*

TD7034 Lilla - *lilac*
TD7035 Arancione - *orange*
TD7036 Bianco - *white*

QUALITY ASSURANCE

The **TOPMASK NON LATEX** has been tested in accordance with EN14683:2006, Type-IIR EC Type examination (Direction 93/42/EEC)
 NELSON Test for Bacterial Filtration Efficiency (BFE)
 NELSON Test for Particle Filtration Efficiency (PFE)
 NELSON Test for Differential Pressure (ΔP)
 NELSON Test for Blood Penetration Resistance
 SGS Test for Allergy Skin Irritation
 SGS Test for Cytotoxicity
 SGS Test for 4-aminoazobenzene (REACH 1907/2006/EC)
 CE certification
 Designed for medical use
 High performance of BFE, PFE and ΔP
 Good performance of anti micro-dust, anti-spray, anti-virus

Mask Features:

1. Outer Layer: Water-repellant, to prevent fluids from entering the mask
2. Middle Layer: Being high level static filtration non-woven, effectively preventing micro dust and bacteria with Bacteria Filtration Efficiency (BFE) at 99.55%, Particle Filtration Efficiency (PFE) >99% at 0.1 μ m, tested by Nelson Lab.
3. Inner Layer: Soft and comfortable PP non-woven
4. Total Mask: Be good at anti-spray, blood penetration resistance at 120mm Hg.

VASSOIO MONOUSO MAXI

Disposable large tray



TD3060

TD3060Z

280x183x17 mm

BOX 400 PCS

TD3060 Fondo liscio - *smooth bottom*TD3060Z Fondo zigrinato - *ribbed bottom*

VASSOIO MONOUSO MAXI COLORATI

Disposable maxi coloured trays



280x183x17 mm

BOX 400 PCS

TD3077ARANCIONE

Arancione - *orange*

TD3077AZZURRO

Azzurro - *blue*

TD3077GIALLO

Giallo - *yellow*

TD3077VERDE

Verde - *green*Fondo zigrinato - *ribbed bottom*

VASSOIO MONOUSO MINI

Disposable mini tray

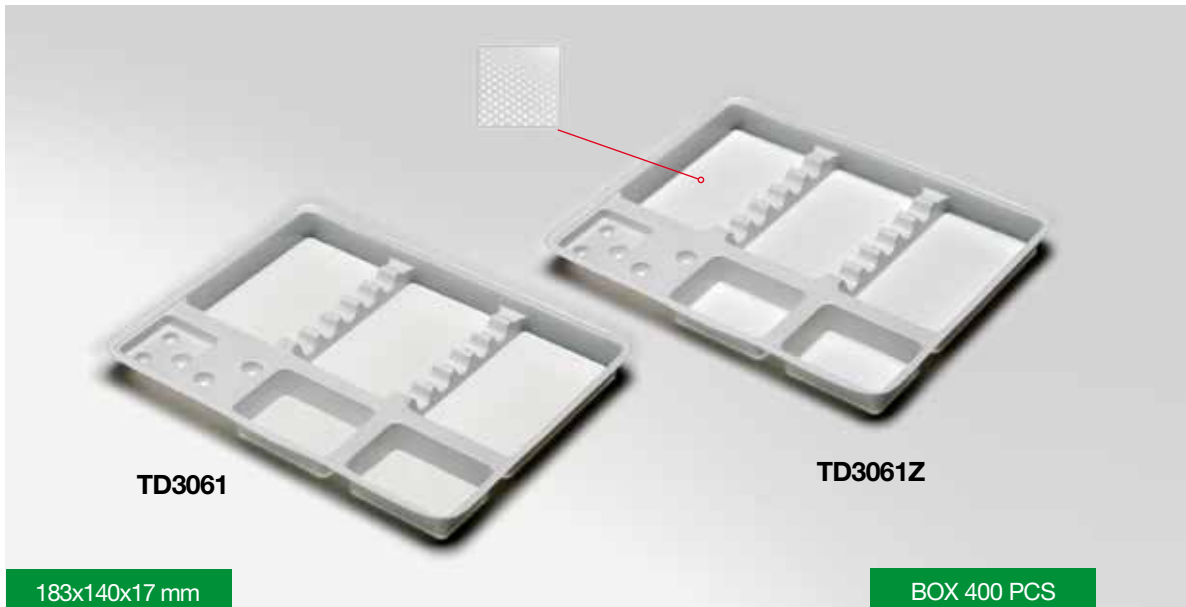

TD3061 Fondo liscio - *smooth bottom*
TD3061Z Fondo zigrinato - *ribbed bottom*

VASSOI MONOUSO MINI COLORATI

Disposable mini coloured trays



TD3078ARANCIONE Arancione - *orange*
TD3078AZZURRO Azzurro - *blue*
TD3078GIALLO Giallo - *yellow*
TD3078VERDE Verde - *green*

Fondo liscio - *smooth bottom*

VASCHETTE MONOUSO MAXI

Disposable maxi basin

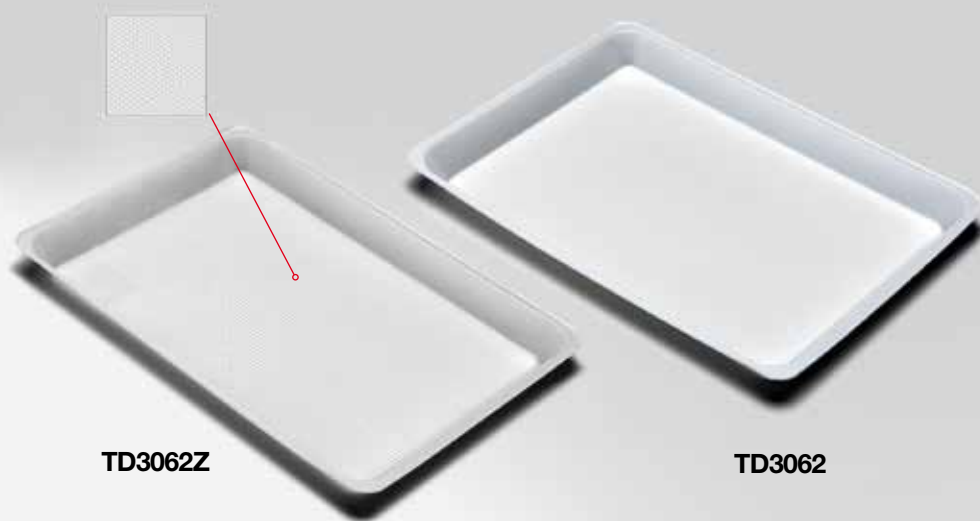

TD3062Z

TD3062

200x150 mm

BOX 400 PCS

TD3062 Fondo liscio - *smooth bottom*
TD3062Z Fondo zigrinato - *ribbed bottom*

VASCHETTE MONOUSO MINI

Disposable mini basin

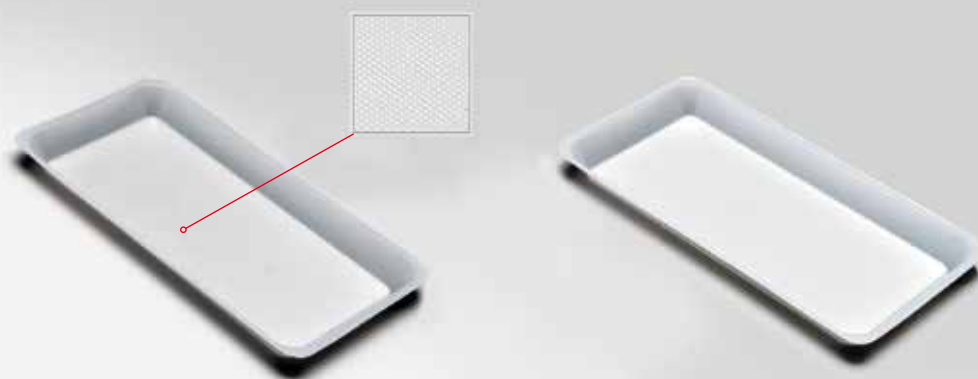

TD3063Z

TD3063

200x100 mm

BOX 400 PCS

TD3063 Fondo liscio - *smooth bottom*
TD3063Z Fondo zigrinato - *ribbed bottom*

**POZZETTO MONOUSO PER MISCELAZIONE
SPATOLINA MONOUSO PER IMPASTO**

*Disposable mixing pallet
Disposable spatula*



TD3064

TD0338

70x55 mm Ø 11 mm

lung. 130 mm

TD3064 Box 1000 Pcs

TD0338 Box 100 Pcs

BACINELLA RENIFORME MONOUSO

Disposable kidney tray



250x135x40 mm

TD3088 pack 50 pcs

PERNI CALCINABILI

Calcinable pins



BOX 100 PCS

- TD7050** mm. 0.6 - Giallo - *yellow*
TD7051 mm. 0.8 - Blu - *blue*
TD7052 mm. 1 - Trasparente - *transparent*
TD7053 mm. 0,8 - Trasparente - *transparent*



PERNI CALCINABILI

Calcinable pins



BOX 60 PCS

2,5 cm

- TD7055** Rosso - *Red*
TD7056 Verde - *Green*

SCATOLA PORTA AGHI USATI*Box for used needles*

34x82xh 120 mm

TD0665**VISIERA PROTETTIVA MONOUSO***Disposable protective shield***TD0700** Box 12 Pcs



TD0710 Kit montatura + 6 visiere - *Kit frame + 6 visors*

OCCHIALI A MASCHERINA MONOUSO MODELLABILE

Disposable mouldable glasses

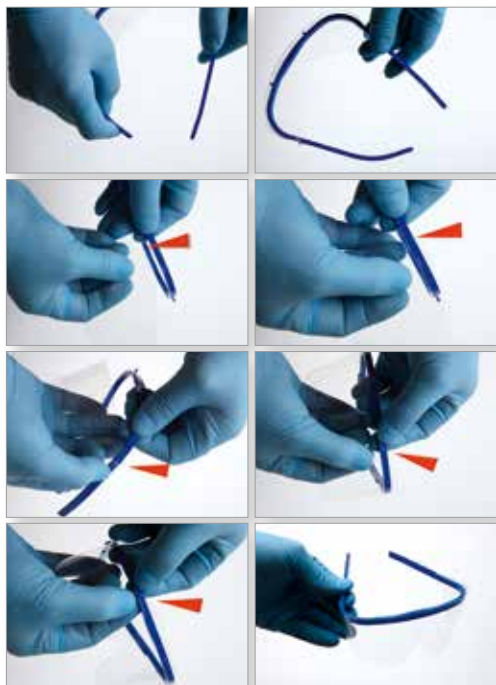

TD0750 Kit da 50 lenti monouso + 5 montature modellabili
Kit of 50 disposable glasses + 5 frames which can be modelled

PORTA RIFIUTI MONOUSO
SUPPORTO PER PORTA RIFIUTI MONOUSO

Disposable waste receiver
Support for waste receiver



BOX 1000 PCS

TD3065 Portarifiuti monouso bianco - *white disposable waste receiver*
TD3066ARG Supporto argento in alluminio - *aluminium silver support*
TD3066BLU Supporto blu in alluminio - *aluminium blue support*

TRAY PAPER STERILIZZABILE

Sterilizable tray paper



Mis. 18x28 cm

BOX 250 PCS

TD0865BLU blu - *blue*
TD0865BIA bianco - *white*
TD0865VER verde - *green*

COPRITESTIERA A BUSTA TOP QUALITY

Headrest cover top quality

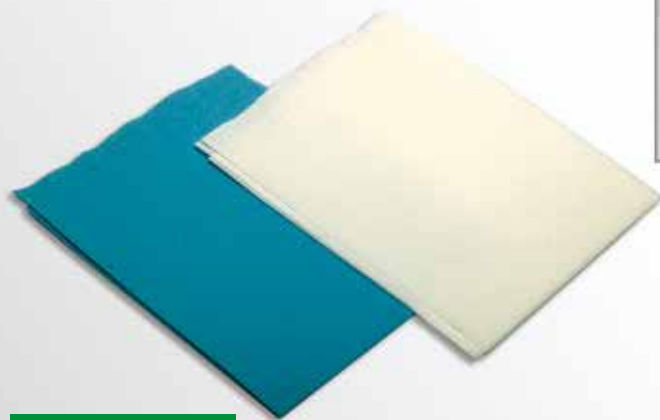

mis. 33x25 cm

BOX 500 PCS

TD0861BIANCO *white*
TD0861BLU *blue*

COPRITESTIERA A BUSTA REGULAR QUALITY

*Headrest cover
regular quality*



mis. 28x28 cm

BOX 1000 PCS

TD0862 *copritestiera a busta bianco*
white headrest cover

RULLI SALIVARI IN COTONE

Cotton rolls



100% cotton

BOX 300 gr x 20

- TD9601 n. 1 Ø 8 mm
- TD9602 n. 2 Ø 10 mm
- TD9603 n. 3 Ø 12 mm

PALLINE DI COTONE

Cotton pellets



TD0644

TD0643

TD0642

- TD0642 *small* Ø 4 mm
- TD0643 *medium* Ø 5,5 mm
- TD0644 *large* Ø 7 mm

6 confezioni da 3 gr. - 6 boxes of 3 g each

TD0900



TD0901

14x18 cm

BOX 25 PCS

TD0900 TNT
TD0901 PE

ROTOLI PER STERILIZZAZIONE

Sterilization flat reels



TD9500 mm 50x200 mt. - box 8 pcs
TD9501 mm 75x200 mt. - box 8 pcs
TD9502 mm 100x200 mt. - box 4 pcs

TD9503 mm 150x200 mt. - box 4 pcs
TD9504 mm 200x200 mt. - box 2 pcs
TD9505 mm 250x200 mt. - box 2 pcs

BUSTE PER STERILIZZAZIONE AUTOSALDANTI

Sterilization self seal pouches



BOX 200 PCS

TD9520 90x230 mm - Lung. tot. 260 mm
TD9521 140x250 mm - Lung. tot. 295 mm

BLOCCHETTI PER IMPASTO IN PVC

Plastic mixing pad



Spessore 1,1 mm - 100 fogli

Thickness 1,1 mm - 100 sheets

TD7090 5x5 - box 6 pcs
TD7091 8x8 - box 6 pcs
TD7092 14x8 - box 3 pcs

BLOCCHETTI PER IMPASTO IN CARTA PLASTIFICATA

*Paper plastified
mixing pad*



100 fogli

100 sheets

- TD7095** 5x5 - box 6 pcs
TD7096 10x10 - box 6 pcs
TD7097 12x18 - box 3 pcs

DAPPEN MONOUSO

Disposable dappen



TD0650 Rosso - red
TD0651 Blu - blue

TD0652 Verde - green
TD0653 Giallo - yellow

TD0654 Bianco - white

Box 50 Pcs

TD0655 Colori misti: blu, rosso, giallo, verde - *Mixed colours: blue, red, yellow, green*
 Box 200 Pcs

BICCHIERINI MONOUSO*Disposable cups*

BOX 1000 PCS - 180 cc

2,5 g - 180 cc - PP

TD3067BIA bianco - *white*
TD3067AZZ azzurro - *light blue*
TD3067LILLA lilla - *lilac*
TD3067ARA arancione - *orange*
TD3067BLU blu - *blue*

TD3067GIA giallo - *yellow*
TD3067MAG magenta - *magenta*
TD3067VER verde fresco - *fresh green*
TD3067ROSA rosa - *pink*

SOVRASCARPE IN POLIETILENE*Polyethylene shoe covers*

BOX 100 PCS

TD0530 PE colore azzurro - *PE blue colour*



BOX 100 PCS

TD0500 50x50
 TD0501 50x75
 TD0502 75x100

box 100 pz

50x50

50x75

75x100

TD0510 scollo ad U 75x100
 U-Shaped type 75x100

box 100 pz

75x100

TD0520 kit chirurgico composto da: 1 telo 50x50, 1 telo 75x100, 2 cuffie verdi, 1 cappellino verde, 2 camici in TNT verde, 2 guaine 7,5x120, 2 adesivi per fissaggio guaine
 Kit personalizzabile

*Surgical kit composed by: 1 drape 50x50, 1 drape 75x100, 2 round surgical green caps, 1 green cap, 2 TNT green gown, 2 sheaths 7,5x120, 2 adhesives to fix the sheaths
 The kit can be personalised*

1 pc

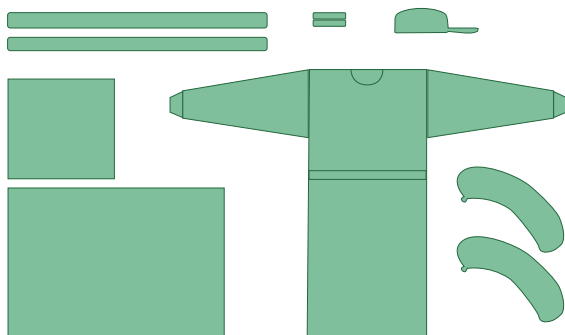

GUANTI MONOUSO IN NITRILE SENZA POLVERE

Nitril gloves without powder



pure nitril soft

TDGN-XS
TDGN-S
TDGN-M
TDGN-L

bianco - *white Xsmall*
bianco - *white Small*
bianco - *white Medium*
bianco - *white Large*

10 box x 100 pcs

GUANTI MONOUSO IN LATTICE SENZA POLVERE

Latex gloves without powder



top touch plus latex extra grip

TDGLPF-XS
TDGLPF-S
TDGLPF-M
TDGLPF-L

lattice naturale - *Xsmall*
lattice naturale - *Small*
lattice naturale - *Medium*
lattice naturale - *Large*

10 box x 100 pcs



ACCESSORI
ACCESSORIES

TAZZE PER ALGINATO E GESSO

Mixing bowls for plaster and alginates

SILICONE

- TD0321 Ø 100 mm
- TD0322 Ø 120 mm
- TD0323 Ø 140 mm
- TD0324 Ø 160 mm

TAZZE PER ALGINATO E GESSO

Mixing bowls for plaster and alginates

POLIETILENE

- TD0331 Ø 100 mm
- TD0332 Ø 120 mm
- TD0333 Ø 140 mm
- TD0334 Ø 160 mm

SPATOLE FLESSIBILI

Flexible spatula

TD0335 celeste tipo morbido - *light blue soft type*

TD0336 blu tipo rigido - *blue hard type*

TD0337 bianca manico anatomico - *white with anatomic handle*

SPATOLE FLESSIBILI COLORATE

Coloured flexible spatula

TD0337 MIX 185 mm

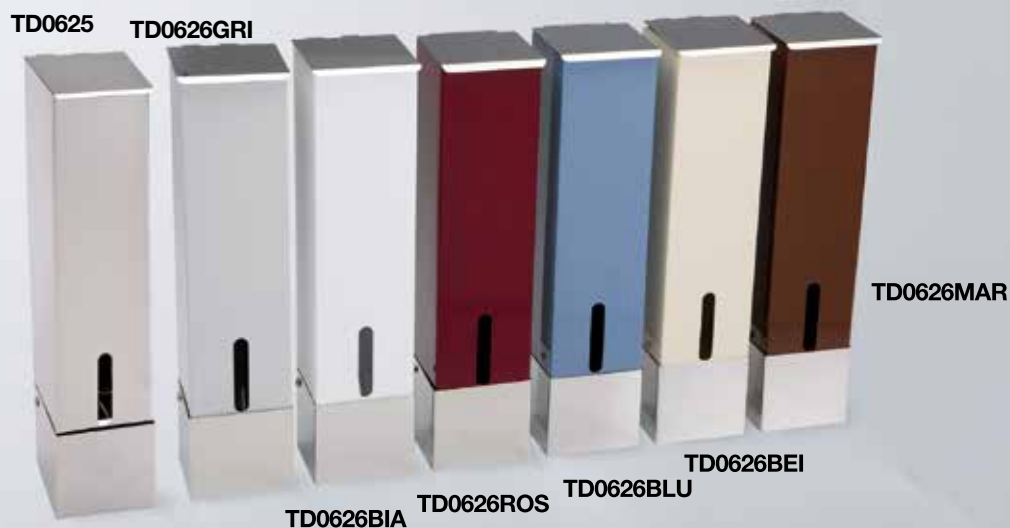
**DISTRIBUTORI PER BICCHIERI
IN METALLO**
Metal drinking cups dispenser

85x85x360 mm

TD0625	inox	TD0626GRI	grigio - <i>grey</i>	TD0626BLU	blu - <i>blue</i>
		TD0626BIA	bianco - <i>white</i>	TD0626BEI	beige - <i>beige</i>
		TD0626ROS	rosso - <i>red</i>	TD0626MAR	marrone - <i>brown</i>

**DISTRIBUTORI PER BICCHIERINI
IN PLASTICA**
Plastic drinking cups dispenser

100x95x320 mm

TD0627 plastica e vetro fumé - *plastic and grey glass*

**DISTRIBUTORI PER PALLINE DI COTONE
IN METALLO**

*Metal cotton pellet
dispenser*



40x40x50 mm

50x50x54,5 mm

TD0641

TD0647 inox

**DISTRIBUTORI PER PALLINE DI COTONE
IN PLASTICA AUTOCLAVABILE**

*Autoclavable plastic cotton
pellets dispenser*

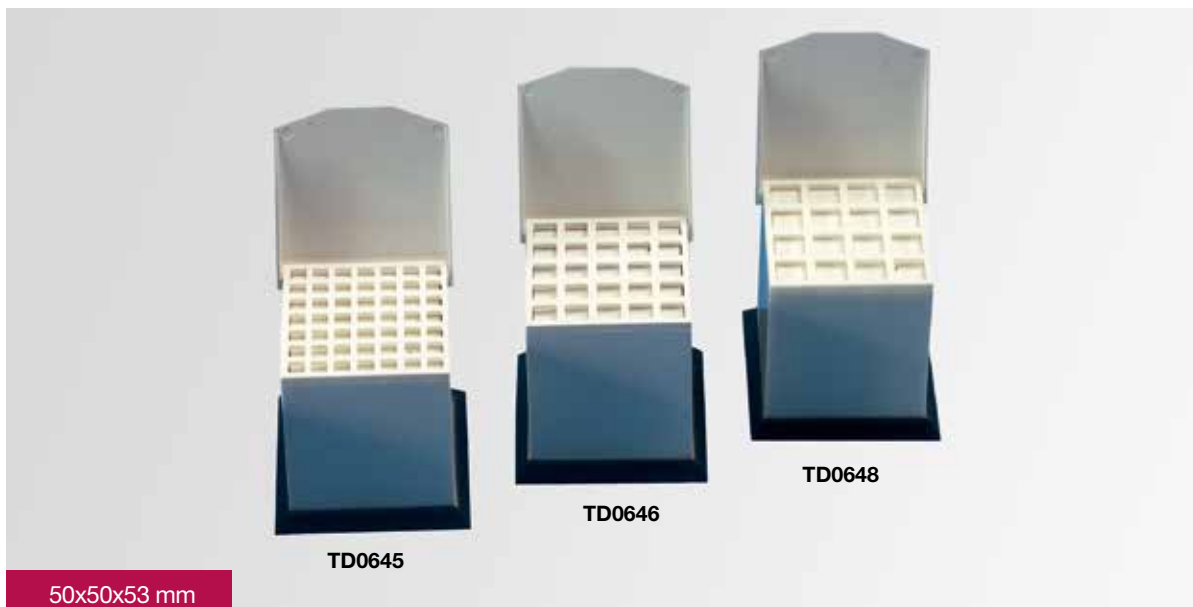

50x50x53 mm

TD0645

TD0646

TD0648

TD0645
TD0646
TD0648

foro piccolo - *small hole*
foro medio - *medium hole*
foro grande - *large hole*

**DISTRIBUTORI PER CANNULE ASPIRASALIVA
IN PLEXIGLASS***Plexiglass saliva ejector
dispenser*

160x140x115 mm

TD0670 **trasparente con coperchio - transparent with cover****DISTRIBUTORE PER MASCHERINE
IN PLEXIGLASS***Plexiglass masks dispenser*

200x120x110 mm

TD0671 **trasparente con coperchio - transparent with cover**

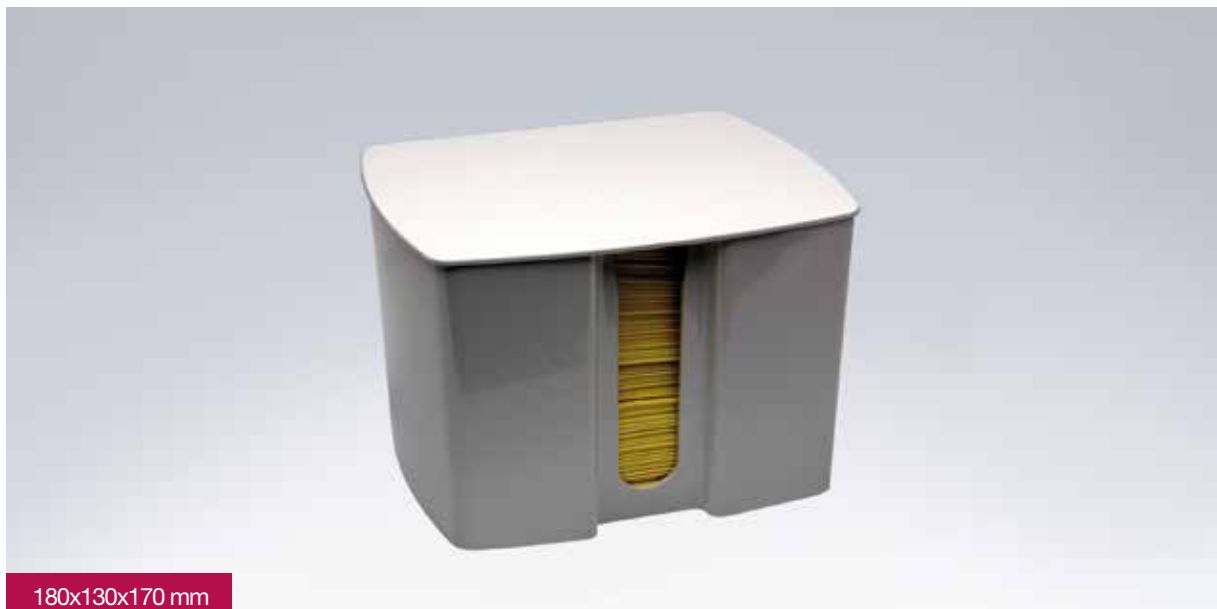
**DISTRIBUTORE PER SALVIETTE
IN PLASTICA***Plastic towels dispenser*

180x130x170 mm

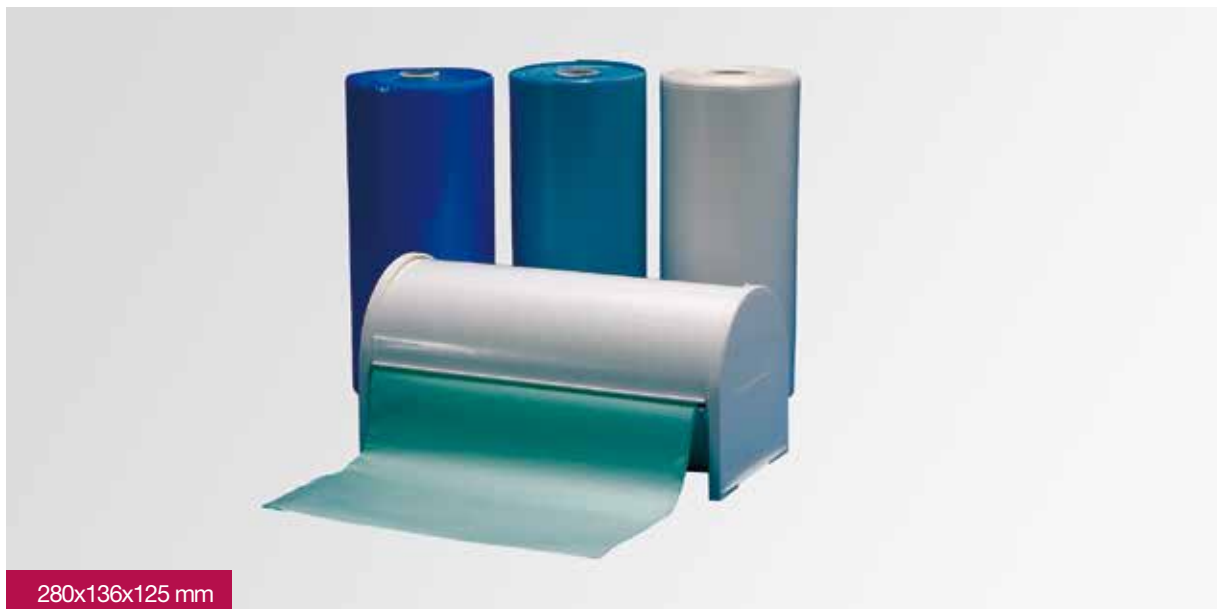
TD0672BIA **apertura frontale - front opening****DISTRIBUTORI PER MANTELLINE
IN PLASTICA***Plastic bibs dispenser*

280x136x125 mm

TD0674BIA

**DISTRIBUTORE PER RULLI
IN PLASTICA**

Plastic cotton rolls dispenser



95x50x100 mm

TD0675BIA bianco - *white*
TD0675GIA giallo - *yellow*
TD0675GRI grigio - *grey*

TD0675BLU blu - *blue*
TD0675ROS rosso - *red*

**DISTRIBUTORE PER RULLI
IN PLASTICA**

Plastic cotton rolls dispenser



140x60x150 mm

TD0676BIA bianco - *white*
TD0676BLU blu - *blue*

caduta rullo individuale - each piece dispensed individually

**DISTRIBUTORE PER RULLI
IN PLASTICA**

*Plastic cotton rolls
dispenser*



TD0677

H 100 mm Ø 100 mm



TD0678

H 50 mm Ø 124 mm

**TD0677
TD0678**

4 scomparti - 4 compartments

**OMNITRAY - VASCHE PER DISINFEZIONE
E STERILIZZAZIONE STRUMENTI DENTALI**

Omnitray for sterilization



TD3110FUCSIA

TD3110GRIGIO

TD3110BLU

TD3110

TD3100

35x26xh14 cm

26x11xh8 cm

**TD3110
TD3110BLU
TD3110FUCSIA
TD3110GRIGIO**

**3 lt bianco - white
3 lt azzurro - blue
3 lt fucsia - fuchsia
3 lt grigio - grey**

TD3100

1 lt bianco - white

ORTHO BOX IN PLASTICA ANTIURTO PER APPARECCHI ORTODONTICI MOBILI

*Plastic orthodontic box for
removable retainers*



65x76x40 mm

bag 10 pz

TD7021NERO	<i>black</i>	TD7021ARANCIONE	<i>orange</i>	TD7021VERDEMARE	<i>sea green</i>
TD7021AZZURRO	<i>blue</i>	TD7021GRIGIO	<i>silver</i>	TD7021VIOLA	<i>violet</i>
TD7021BIANCO	<i>white</i>	TD7021ROSA	<i>pink</i>	TD7021ORO	<i>gold</i>
TD7021BLU	<i>dark blue</i>	TD7021ROSSO	<i>red</i>	TD7021SMERALDO	<i>emerald green</i>
TD7021FUCSIA	<i>fuchsia</i>	TD7021VERDE	<i>green</i>		
TD7021GIALLO	<i>yellow</i>	TD7021GIALLOFLUO	<i>fluo yellow</i>	TD7021	<i>col. assortiti - mixed colours</i>

ORTHO BOX IN PLASTICA ANTIURTO PER APPARECCHI ORTODONTICI MOBILI

*Plastic ortho-box for
removable retainers*



55x75x40 mm

bag 10 pz

TD7020 Mix colori assortiti - *Mixed colours*

PORTA BITE

Box for bite

bag 10 pz

TD7022ARANCIONE *orange*
TD7022AZZURRO *blue*
TD7022BIANCO *white*
TD7022BLU *dark blu*
TD7022BLUMETAL *glittered dark blu*
TD7022GIALLO *yellow*

TD7022FUCSIA *fuchsia*
TD7022LILLA *lilla*
TD7022LIME *lime*
TD7022ROSSO *red*
TD7022VERDE *green*

SCATOLE PORTA PROTESI

Box for prothesis with filter

CON FILTRO

TD7025AZZURRO *blue*
TD7025BIANCO *white*
TD7025BLU *dark blue*

TD7025GIALLO *yellow*
TD7025FUCSIA *fuchsia*
TD7025VERDE *green*

CONTENITORI PER ENDODONZIA MAXI
in alluminio anodizzato completi di coperchio

*Aluminium endodontic maxi
boxes - complete with lid*



TD1000BLU

TD1000ARG

TD1000ROS

204x105x54 mm

TD1000ARG scatola argento - *silver box*
TD1000BLU scatola blu - *blue box*
TD1000ROS scatola rosso - *red box*

5x72 strumenti manuali

CONTENITORI PER ENDODONZIA MAXI
in alluminio anodizzato completi di coperchio

*Aluminium endodontic maxi
boxes - complete with lid*

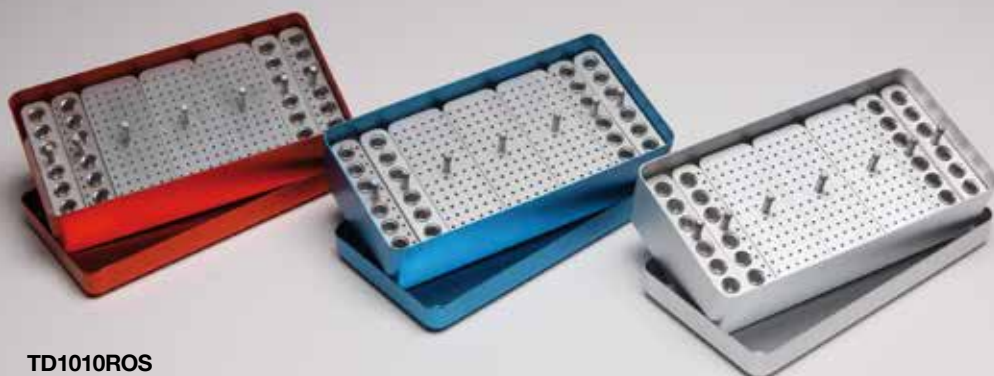

TD1010ROS

TD1010BLU

TD1010ARG

204x105x54 mm

TD1010ARG scatola argento - *silver box*
TD1010BLU scatola blu - *blue box*
TD1010ROS scatola rosso - *red box*

3x72 strumenti manuali + 4x6 tubetti
+ 12 strumenti RA

CONTENITORI PER ENDODONZIA MAXI
in alluminio anodizzato completi di coperchio

*Aluminium endodontic maxi
boxes - complete with lid*



TD1020



TD1025

204x105x54 mm

TD1020 scatola argento - *silver box*
TD1025 scatola argento - *silver box*

2x48 FG + 1x48 RA + 1x48 misti + 1x12 tubetti
1x48 FG + 1x48 RA + 1x40 misti + 1x72 strumenti manuali
+1x12 tubetti

CONTENITORI PER ENDODONZIA MAXI
in alluminio anodizzato completi di coperchio

*Aluminium endodontic maxi
boxes - complete with lid*



TD1030BLU



TD1030ARG



TD1030ROS

204x105x54 mm

TD1030ARG scatola argento- *silver box*
TD1030BLU scatola blu- *blue box*
TD1030ROS scatola rossa- *red box*

210 strumenti manuali
+ 153 RA + 24 tubetti

CONTENITORI PER ENDODONZIA MAXI
in alluminio anodizzato completi di coperchio

*Aluminium endodontic maxi
 boxes - complete with lid*



TD1055

TD1050

TD1056

204x105x54 mm

TD1050 scatola blu interno blu - *blue box blue tray*
TD1056 scatola argento interno blu - *silver box blue tray*
 272 strumenti manuali

TD1055 scatola argento interno blu - *silver box blue tray*
 strumenti misti + tubetti

CONTENITORI PER ENDODONZIA MEDI
in alluminio anodizzato completi di coperchio

*Aluminium endodontic medium
 boxes - complete with lid*

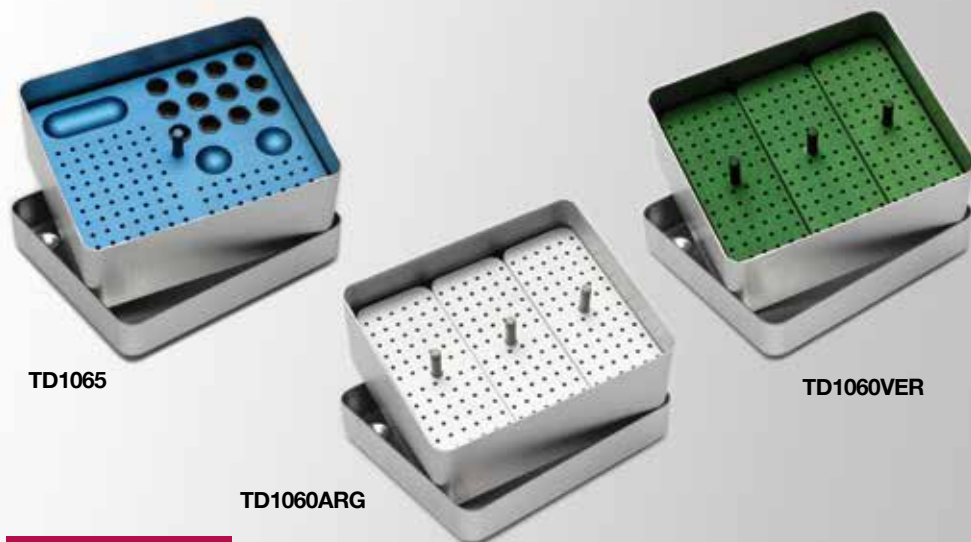

TD1065

TD1060ARG

TD1060VER

125x105x54 mm

TD1060ARG scatola e interni argento - *silver box and tray*
TD1060VER scatola argento interno verde - *silver box green tray*
TD1065 scatola argento interno blu - *silver box blue tray*

3x72 strumenti manuali
 3x72 strumenti manuali
 strumenti manuali + tubetti

CONTENITORI PER ENDODONZIA
in alluminio anodizzato completi di coperchio

*Aluminium endodontic
boxes - complete with lid*



L-S050A	104x44x54 mm
L-S053A	60x45x50 mm
L-S070A	125x105x54 mm
L-S140A	204x105x54 mm
L-S150A	204x105x30 mm

CONTENITORI PER ENDODONZIA MINI
in alluminio anodizzato completi di coperchio

*Aluminium endodontic mini
boxes - complete with lid*



104x44x54 mm

TD1070ARG	scatola argento - <i>silver box</i>
TD1070ROS	scatola rossa - <i>red box</i>
TD1070BLU	scatola blu - <i>blue box</i>
TD1070ORO	scatola oro - <i>gold box</i>
TD1070VERARG	scatola verde - <i>green box</i>
TD1070VERVER	scatola verde interno verde - <i>green box green tray</i>
TD1070ARGVER	scatola argento interno verde - <i>silver box green tray</i>

72 strumenti manuali

CONTENITORI PER ENDODONZIA MINI
in alluminio anodizzato completi di coperchio

*Aluminium endodontic mini
boxes - complete with lid*



TD1080ORO

TD1080VER

TD1080ARG

TD1080ROS

TD1080BLU

104x44x54 mm

TD1080ARG scatola argento - *silver box*
TD1080VER scatola verde - *green box*
TD1080BLU scatola blu - *blue box*
TD1090ORO scatola oro - *gold box*
TD1080ROS scatola rossa - *red box*

24 RA + 24 strumenti manuali +
4 tubetti

CONTENITORI PER ENDODONZIA MINI
in alluminio anodizzato completi di coperchio

*Aluminium endodontic mini
boxes - complete with lid*



TD1090ARG

TD1090ROS

TD1090VERVER

TD1090BLU

TD1090ORO

104x44x54 mm

TD1090ARG scatola argento - *silver box*
TD1090ROS scatola rossa - *red box*
TD1090VER scatola verde - *green box*
TD1090BLU scatola blu - *blue box*
TD1090ORO scatola oro - *gold box*

12 RA + 12 strumenti manuali
+ 2 tubetti

CONTENITORI PER ENDODONZIA MINI
in alluminio anodizzato completi di coperchio

*Aluminium endodontic mini
boxes - complete with lid*



TD1120ARGBLU

TD1120VER

TD1120BLUBLU

104x44x54 mm

TD1120ARGBLU
TD1120VER
TD1120BLUBLU

scatola argento interno blu - *silver box blue tray*
scatola verde interno verde - *green box green tray*
scatola blu interno blu - *blue box blue tray*

48 strumenti manuali

CONTENITORI PER ENDODONZIA MINI
in alluminio anodizzato completi di coperchio

*Aluminium endodontic mini
boxes - complete with lid*



TD1110ARG

TD1110ORO

104X44X54 mm

TD1110ORO
TD1110ARG

scatola oro - *gold box*
scatola argento - *silver box*

48 strumenti RA

CONTENITORI PER ENDODONZIA MINI
in alluminio anodizzato completi di coperchio

*Aluminium endodontic
boxes - complete with lid*



104x44x54 mm

TD1140ROS scatola rossa - red box
TD1140ARG scatola argento - silver box

24 RA + 24 strumenti manuali

CONTENITORI PER ENDODONZIA MINI
in alluminio anodizzato completi di coperchio

*Aluminium endodontic
boxes - complete with lid*



104x44x54 mm

TD1100 scatola argento - silver box
TD1130 scatola argento - silver box

12 strumenti manuali + 12 tubetti
12 tubetti

CONTENITORI ROTONDI PER ENDODONZIA
in alluminio anodizzato completi di coperchio

*Round aluminium endodontic
 boxes - complete with lid*



Ø 48 h62 mm

TD1160ARG scatola argento - *silver box*
TD1160BLU scatola blu - *blue box*
TD1160ORO scatola oro - *gold box*
TD1160ROS scatola rossa - *red box*
TD1160VER scatola verde - *green box*

18 strumenti manuali

CONTENITORI ROTONDI PER ENDODONZIA
in alluminio anodizzato completi di coperchio

*Round aluminium endodontic
 boxes - complete with lid*



Ø 48 h62 mm

TD1170ARG scatola argento - *silver box*
TD1170ROS scatola rossa - *red box*
TD1170VER scatola verde - *green box*
TD1170BLU scatola blu - *blue box*
TD1170ORO scatola oro - *gold box*

6 tubetti

CONTENITORE PER ENDODONZIA ROTONDO
in alluminio anodizzato completi di coperchio

*Round aluminium endodontic
boxes - complete with lid*



TD1150

Ø 94 h70 mm

TD1150 scatola argento - silver box

64 strumenti + 4 tubetti

TRAY PER ENDODONZIA
in alluminio anodizzato

*Aluminium endodontic
tray - complete with lid*



TD1190

257x116x16 mm

TD1190 argento - silver

ARTICOLATORI E PORTA LASTRINE

Articulator-inox clips

TD3200

TD3221

TD3200 articolatore occlusore a filo - *articulator occlusor*
TD3221 pinzette porta lastrine acciaio inox - *inox clips*

70 mm

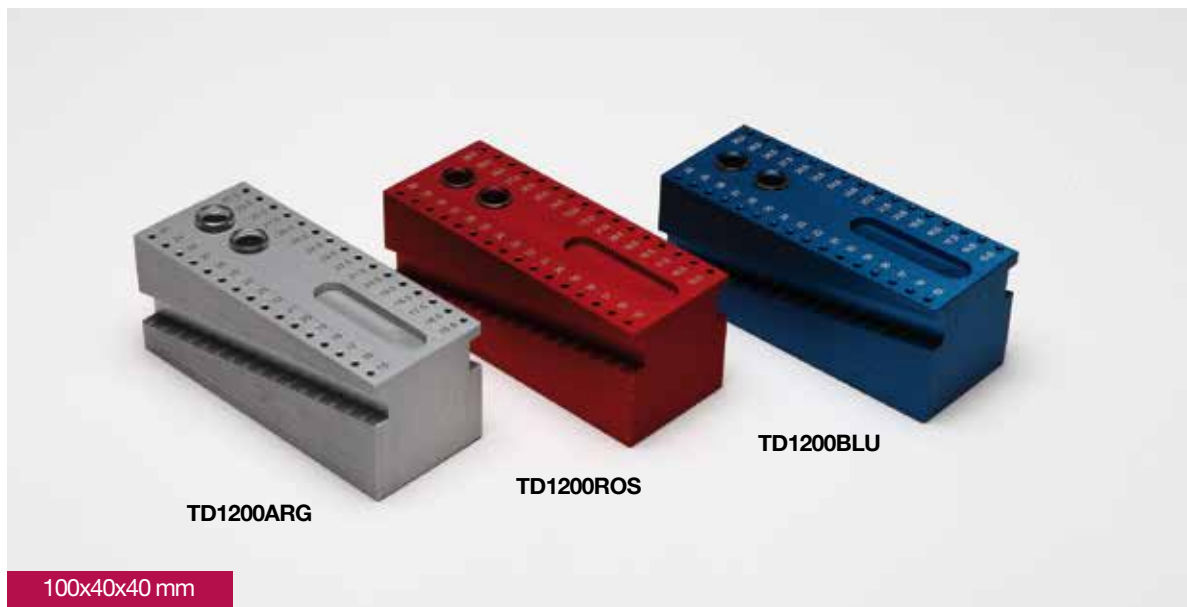
MISURATORI PER STRUMENTI CANALARI
in alluminio anodizzato
Aluminium endometer

TD1200ARG

TD1200ROS

TD1200BLU

100x40x40 mm

TD1200ARG argento - *silver*
TD1200BLU blu - *blue*
TD1200ROS rosso - *red*

**MISURATORE PER STRUMENTI CANALARI
CON SCALA DI PROFONDITÀ - in alluminio anodizzato**

*Aluminium endometer
with depth scale*



**NEW MODEL
WITH DEPTH SCALE**

100x40x40 mm

TD1220ARG argento - silver

**MISURATORI PER STRUMENTI CANALARI
in alluminio anodizzato**

Aluminium endometer



Ø 34 h 48 mm

TD1210ARG argento - silver
TD1210ROS rosso - red
TD1210BLU blu - blue

PULITORI PER STRUMENTI CANALARI
in alluminio anodizzato

*Aluminium endodontic
 instrument cleaners*



- TD1240** aperto - *open* - Ø40 - 30 mm
TD1241 chiuso - *closed* - Ø40 - 30 mm
TD1243 rotondo - *rounded* - Ø35 - 33 mm

PULITORE PER STRUMENTI CANALARI
IN PLASTICA AUTOCLAVABILE

*Autoclavable plastic endodontic
 instrument cleaners*



H 30 mm Ø 45 mm

- TD1244BLU** blu - *blue*
TD1244ROS rosso - *red*
TD1244VER verde - *green*

SPUGNETTE PER ENDODONZIA

*Disposable sponges for
endodontic instruments cleaners*

TD1242



TD1245

TD1242
TD1245

Ø 50 mm h 5 mm
Ø 65 mm h 5 mm

PORTA AMALGAMA

Amalgam well

TD2301

TD2300

TD2300 - Mod. 1
TD2301 - Mod. 2

SIRINGHE PER AMALGAMA AUTOCLAVABILE

Autoclavable amalgam gun



- TD0681** Siringa curva autoclavabile - amalgam gun curved autoclavable
TD0682 Siringa dritta autoclavabile - amalgam gun straight autoclavable
TD0680 Mortaio per amalgama bianco autoclavabile - amalgam mortar white autoclavable

SUPPORTO UNIVERSALE con endobox mini

*Universal supports
with mini endobox*



- TD2190** Scatola mini endobox argento + supporto universale 36 fori piccoli Ø 2 mm
Mini silver endodontic box + universal support with 36 little inserts Ø 2 mm

**BASE PER PUNTE DEL SINDESMOTOMO
IN ALLUMINIO ANODIZZATO**

*Aluminium syndesmotome
tips holder*

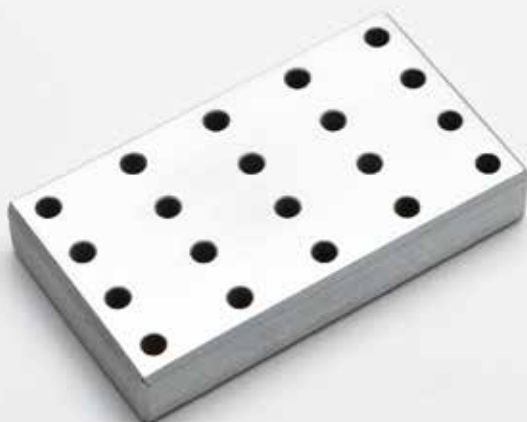

70x40x12 mm

TD2095 20 fori - 20 holes

**PORTA STRUMENTI CANALARI-
PIASTRINE PORTA FRESE**

*Aluminium canal instruments holder-
Aluminium low mill holder*

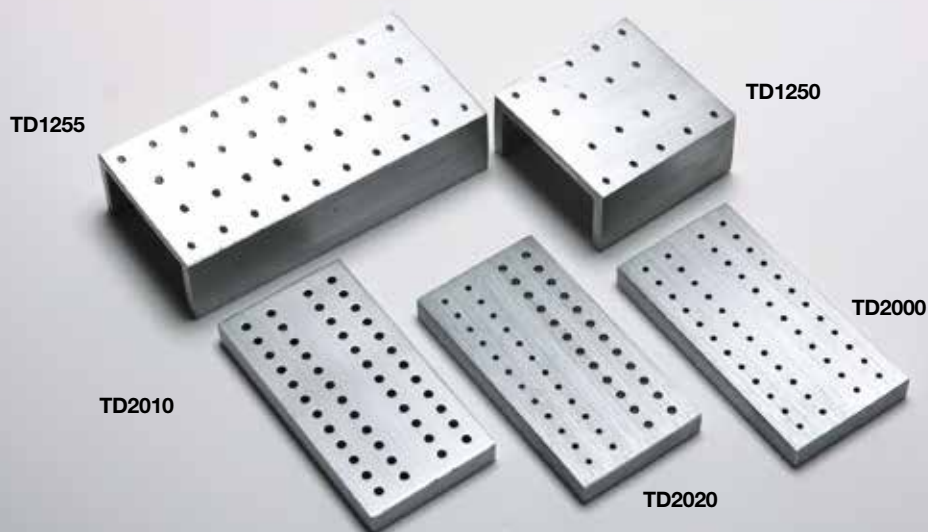

ALLUMINIO ANODIZZATO

TD1250 - 50x50x25 mm
TD1255 - 100x50x25 mm
TD2000 - 75x40 mm
TD2010 - 75x40 mm
TD2020 - 75x40 mm

PORTA FRESE IN ALLUMINIO ANODIZZATO

Aluminium mill holders

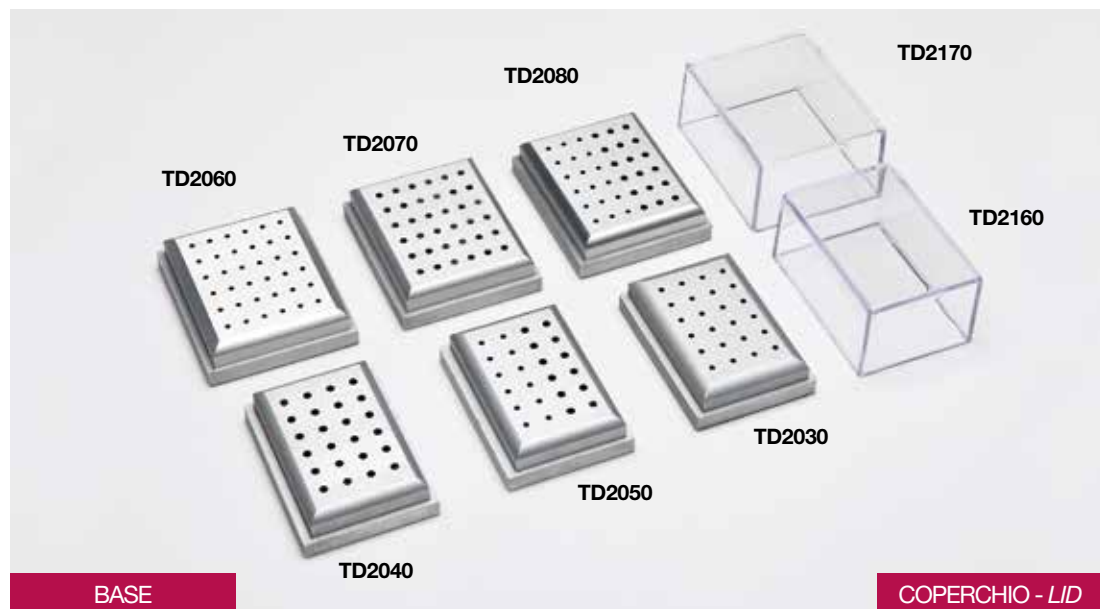

TD2030 - 24 FG 60x40 mm
TD2040 - 24 RA 60x40 mm
TD2050 - 24 FG-RA 60x40 mm
TD2060 - 36 FG 60x50 mm

TD2070 - 36 RA 60x50 mm
TD2080 - 36 FG-RA 60x50 mm
TD2160 - 24 fori 60x40x30 mm
TD2170 - 36 fori 60x50x30 mm

PORTA FRESE IN PLEXIGLAS

Plexiglas mill holders

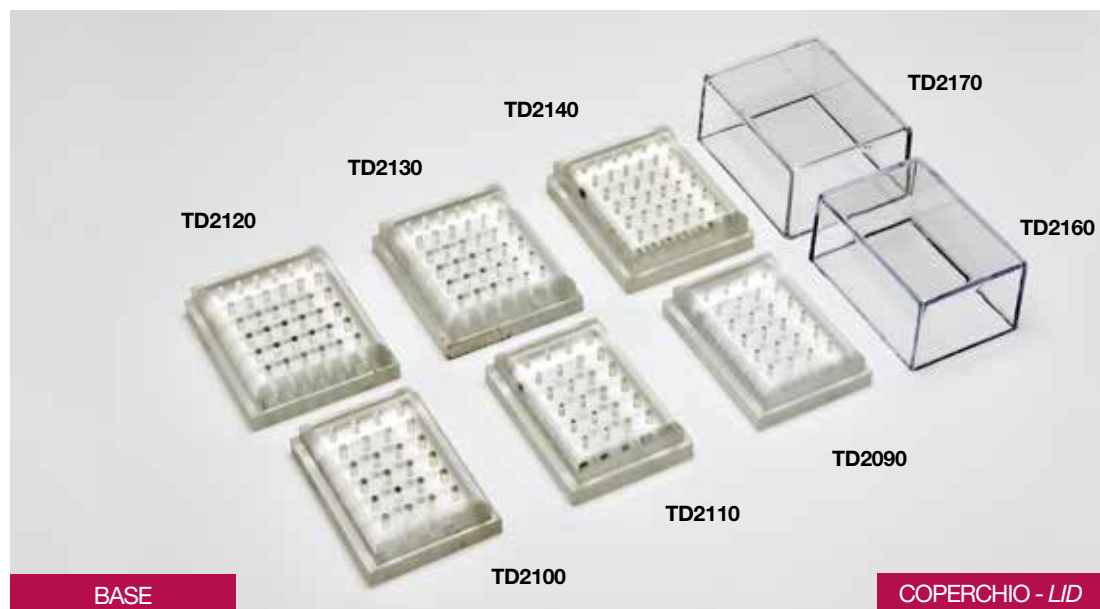

TD2090 - 24 FG 60x40 mm
TD2100 - 24 RA 60x40 mm
TD2110 - 24 FG-RA 60x40 mm
TD2120 - 36 FG 60x50 mm
TD2130 - 36 RA 60x50 mm
TD2140 - 36 FG-RA 60x50 mm

TD2160 - 24 fori 60x40x30 mm
TD2170 - 36 fori 60x50x30 mm

**SCATOLA PORTA FRESE IN ALLUMINIO
ANODIZZATO CON INSERTI**

*Aluminium box for mill holders
with 7 inserts and lid*



TD2200

125x105x55 mm

TD2200 box con 7 interni estraibili e coperchio - *box with 7 insert trays and lid*

**INTERNI PORTA FRESE E SUPPORTO
IN ALLUMINIO ANODIZZATO**

*Aluminium inserts trays
and support*

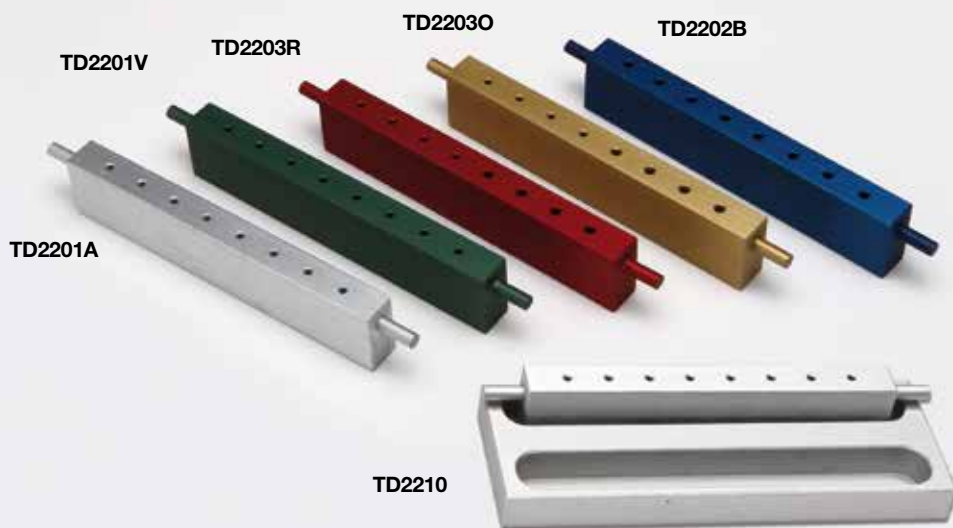

TD2201V

TD2203R

TD2203O

TD2202B

TD2201A

TD2210

INTERNI - INSERT TRAYS

SUPPORTO - SUPPORT

TD2201A - FG argento - *silver*
TD2201V - FG verde - *green*
TD2202B - RA blu - *blue*
TD2203O - FG-RA oro - *gold*
TD2203R - FG-RA rosso - *red*

TD2210 - Supporto due vani

VASSOI PORTA STRUMENTI MAXI
LISCI-COPERCHIO - in alluminio anodizzato

*Aluminium standard
 maxi instrument trays-lid*



VASSOI - TRAY

COPERCHIO - LID

TD3000 rosso - red
TD3001 blu - blue
TD3002 verde - green
TD3003 oro - gold
TD3004 argento - silver

mis. 284x183x17 mm

TD3010 argento - silver
 mis. 288x187x29 mm

VASSOI PORTA STRUMENTI MINI
LISCI-COPERCHIO - in alluminio anodizzato

*Aluminium solid mini
 instrument trays lid*

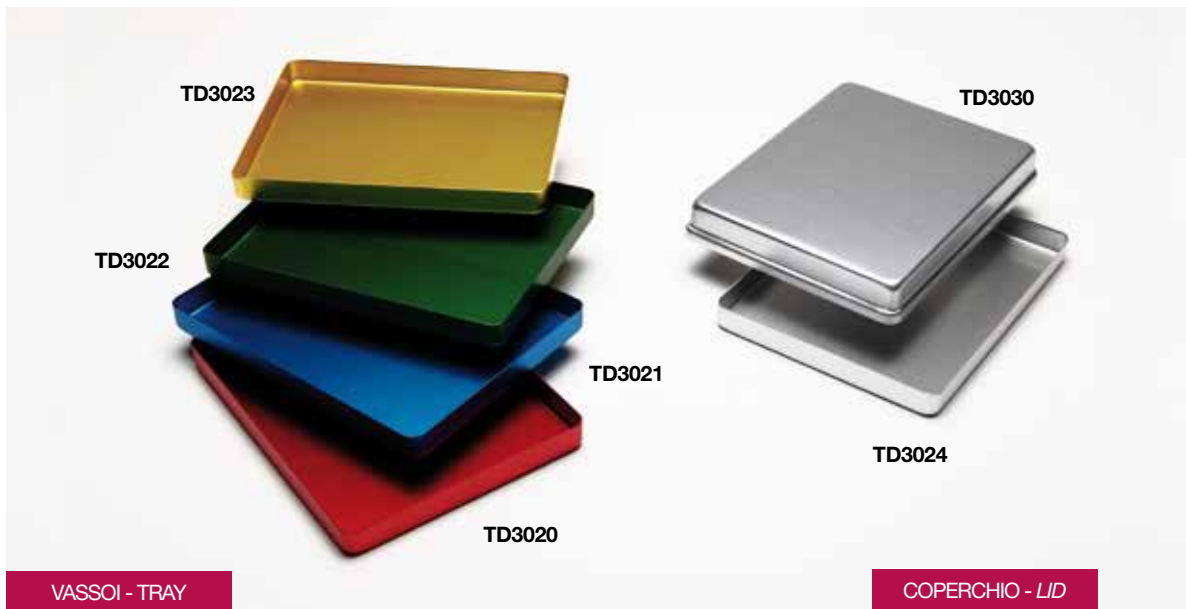

VASSOI - TRAY

COPERCHIO - LID

TD3020 rosso - red
TD3021 blu - blue
TD3022 verde - green
TD3023 oro - gold
TD3024 argento - silver

mis. 183x140x17 mm

TD3030 argento - silver
 mis. 187x145x25 mm

VASCHETTE E INSERTI in alluminio anodizzato

*Aluminium instruments basin
and inserts*

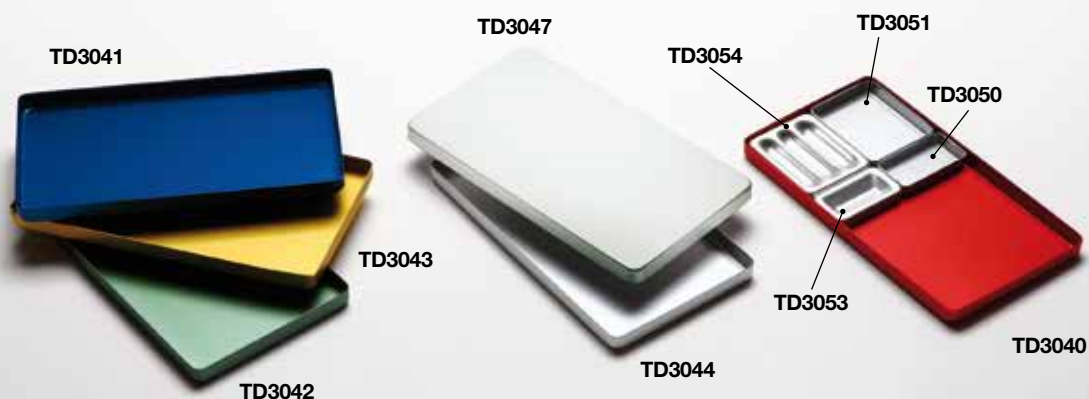

VASSOI - TRAY

TD3040 rosso - red
TD3041 blu - blue
TD3042 verde - green
TD3043 oro - gold
TD3044 argento - silver
 mis. 180X100X11 mm

TD3047
 coperchio argento - silver lid
 mis. 182X103X13 mm

INSERTI - INSERT

TD3050 49x26x10 mm
TD3051 59x49x10 mm
TD3053 49x26x10 mm
TD3054 59x49x10 mm

VASSOI PORTA STRUMENTI MAXI CON SUPPORTI in alluminio anodizzato

*Aluminium maxi
instrument trays with supports*

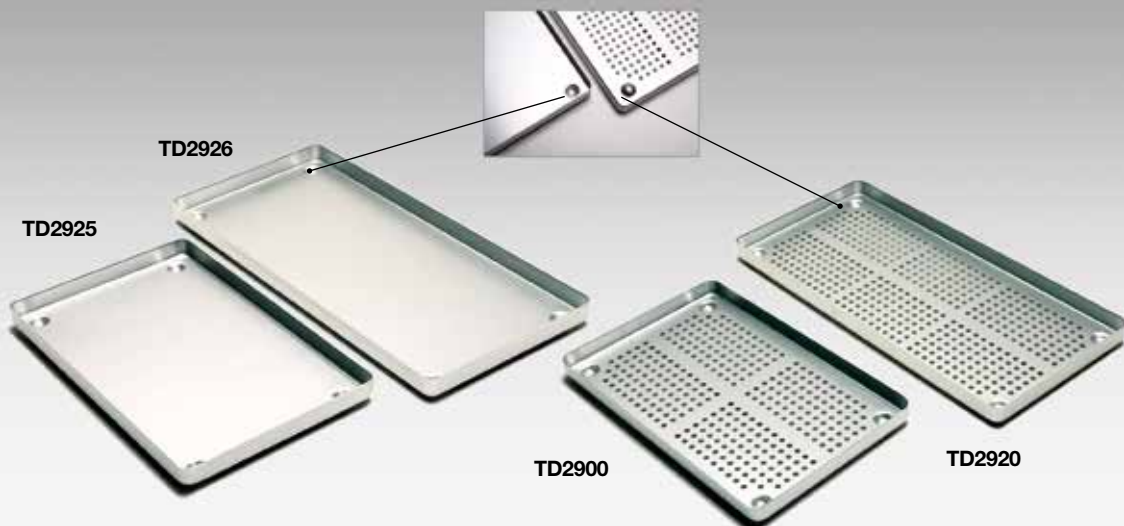

LISCI - STANDARD

TD2925 liscio mis. 284x183x17 mm
TD2926 liscio mis. 384x183x17 mm

FORATI - PERFORATED

TD2900 forato mis. 284x183x17 mm
TD2920 forato mis. 384x183x17 mm

**VASSOI PORTA STRUMENTI MAXI
FORATI-COPERCHIO - in alluminio anodizzato**

*Aluminium perforated
maxi instrument trays-lid*

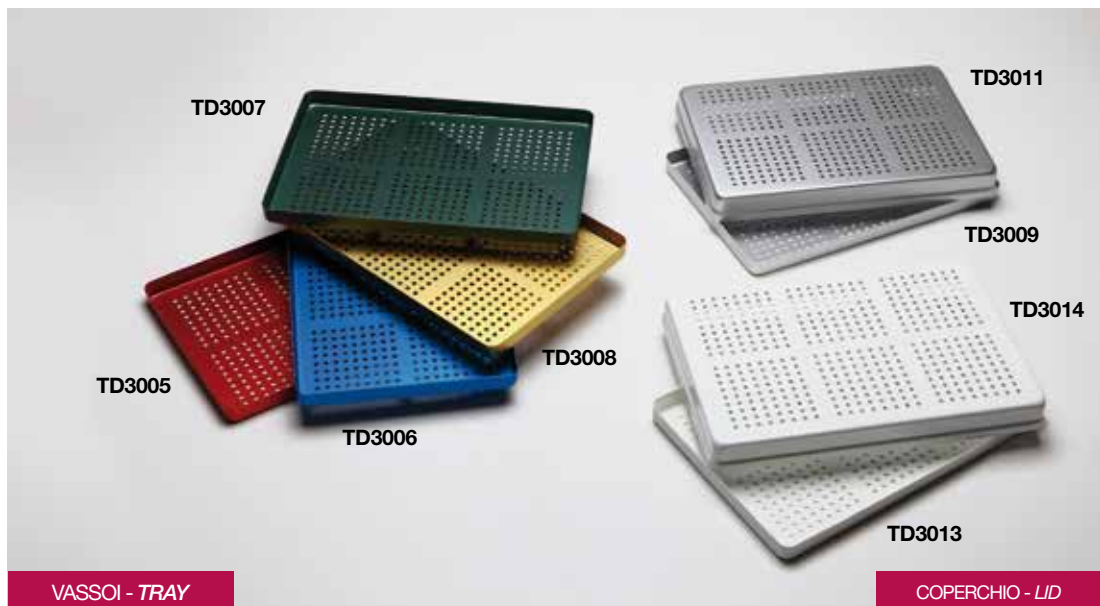

VASSOI - TRAY

COPERCHIO - LID

TD3005 rosso - red

TD3006 blu - blue

TD3007 verde - green

mis. 284x183x17 mm

TD3008 oro - gold

TD3009 argento - silver

TD3013 rylsan bianco - white

TD3011 argento - silver

TD3014 rylsan bianco - white

mis. 288x187x29 mm

**VASSOI PORTA STRUMENTI MINI
FORATI-COPERCHIO - in alluminio anodizzato**

*Aluminium perforated
mini instrument trays-lid*

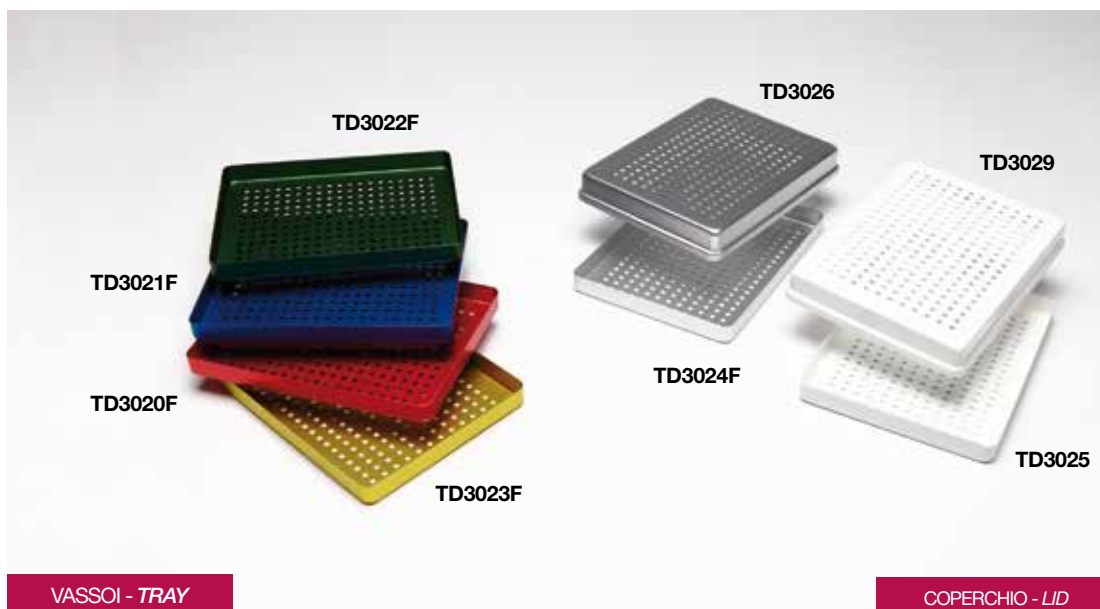

VASSOI - TRAY

COPERCHIO - LID

TD3020F rosso - red

TD3021F blu - blue

TD3022F verde - green

mis. 183x140x17 mm

TD3023F oro - gold

TD3024F argento - silver

TD3025 rylsan bianco - white

TD3026 argento - silver

TD3029 rylsan bianco - white

mis. 187x145x25 mm



TD2922

TD2921

440x184x17 mm

TD2921 forato - perforated

TD2922 liscio- solid

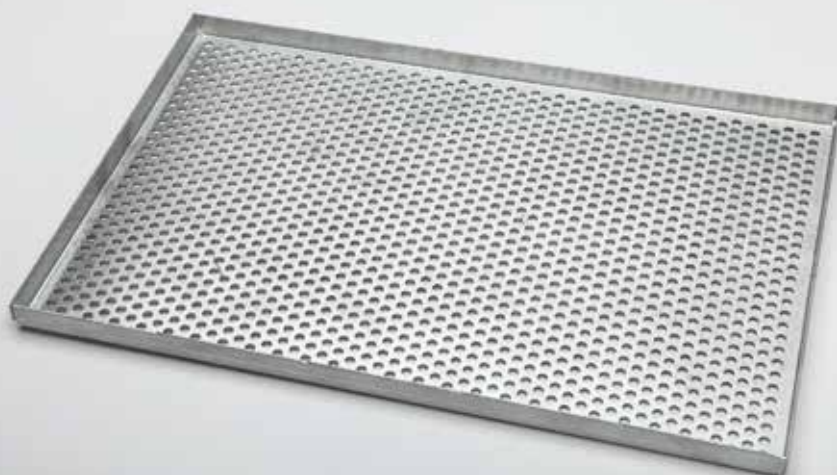

370x245x10 mm

TD2928 alluminio - aluminium

VASSOIO ACCIAIO MAGNUM*Magnum stainless steel trays*

440x184x17 mm

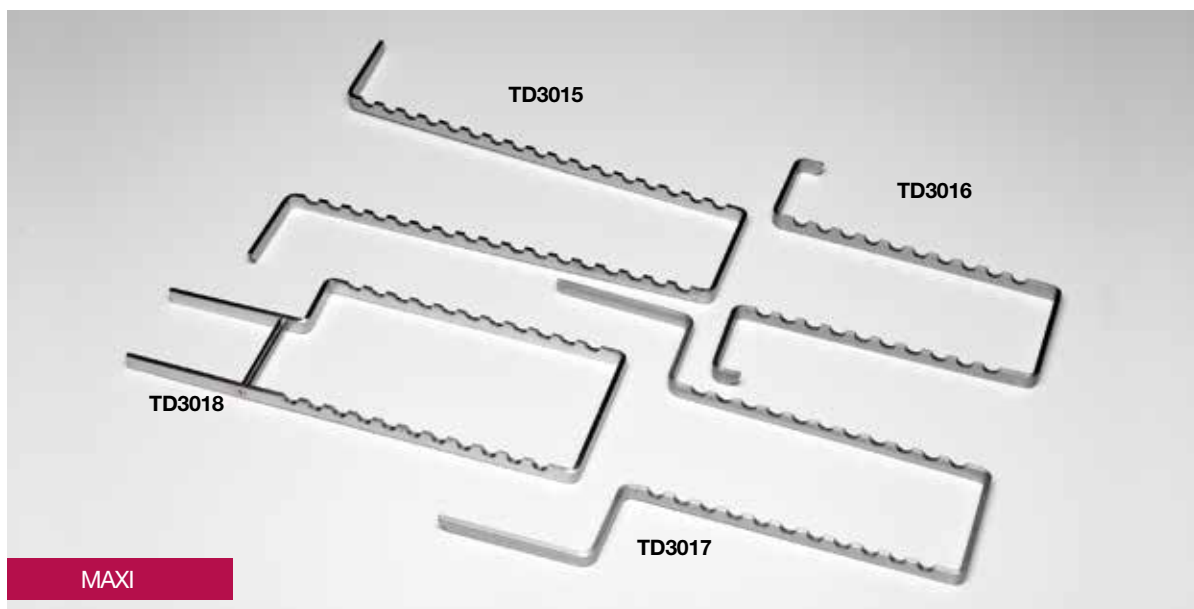
TD2927 acciaio - *stainless steel***RASTRELLIERE PORTA STRUMENTI MAXI**
*in alluminio anodizzato**Maxi insert frame***MAXI**

- TD3015** 17 sedi - 17 *instruments*
- TD3016** 10 sedi - 10 *instruments*
- TD3017** standard 11 sedi - 11 *instruments*
- TD3018** con tirante 11 sedi - 11 *instruments*

RASTRELLIERE PORTA STRUMENTI MINI
in alluminio anodizzato

Mini insert frame

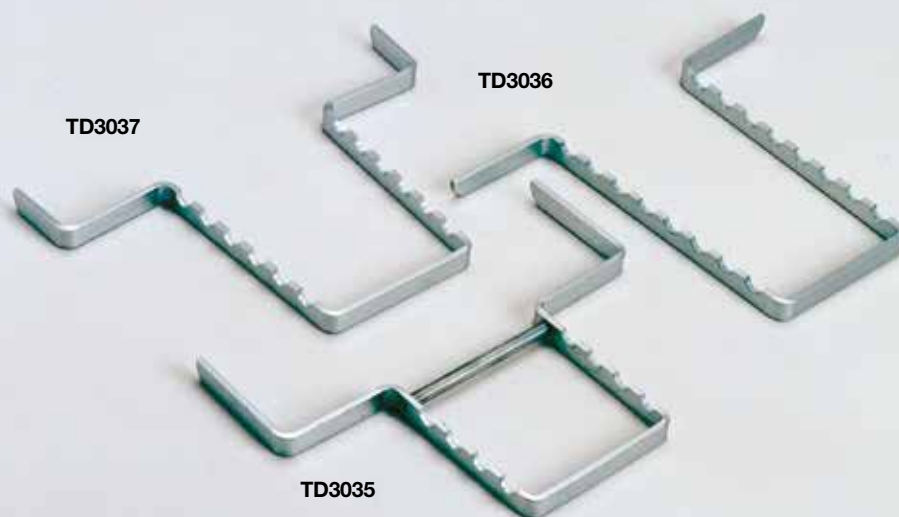

MINI

- TD3035** 4 sedi - 4 instruments
TD3036 8 sedi - 8 instruments
TD3037 6 sedi - 6 instruments

PORTA VASSOI
in alluminio anodizzato

Aluminium tray rack



- TD3012** MAXI - mis. 295x190x270 mm
TD3028 MINI - mis. 150x180x270 mm

PORTA VASSOI RYLSAN BIANCHI

White rylsan tray rack

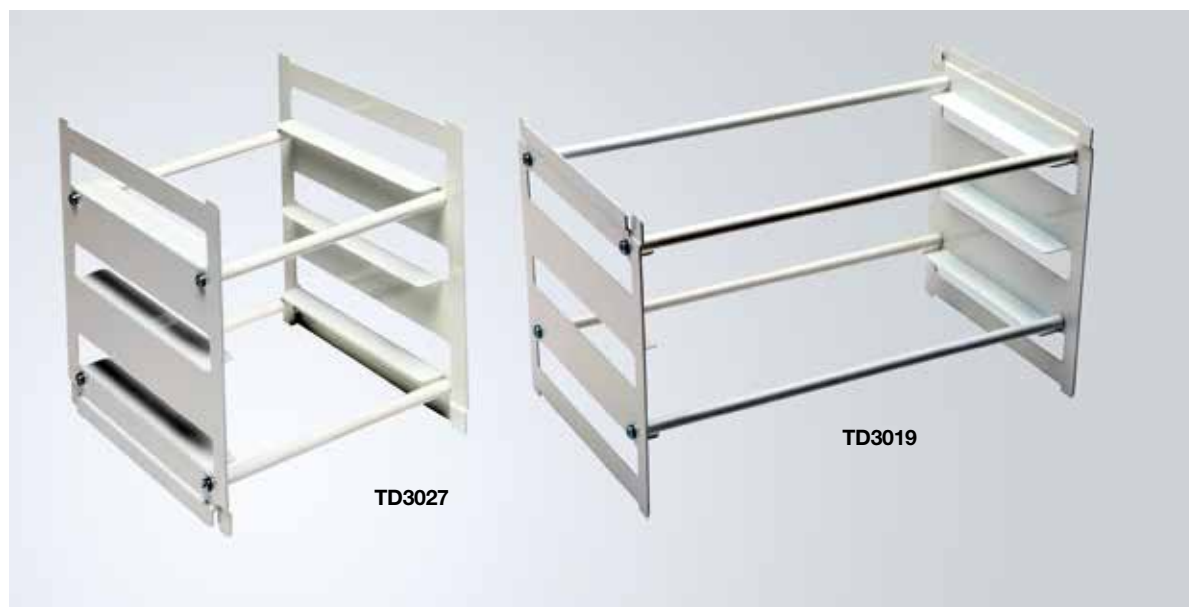

TD3019 MAXI - mis. 295x175x180 mm
TD3027 MINI - mis. 150x175x180 mm

VASSOI PORTASTRUMENTI MAXI in acciaio inox

Stainless steel maxi
instrument tray

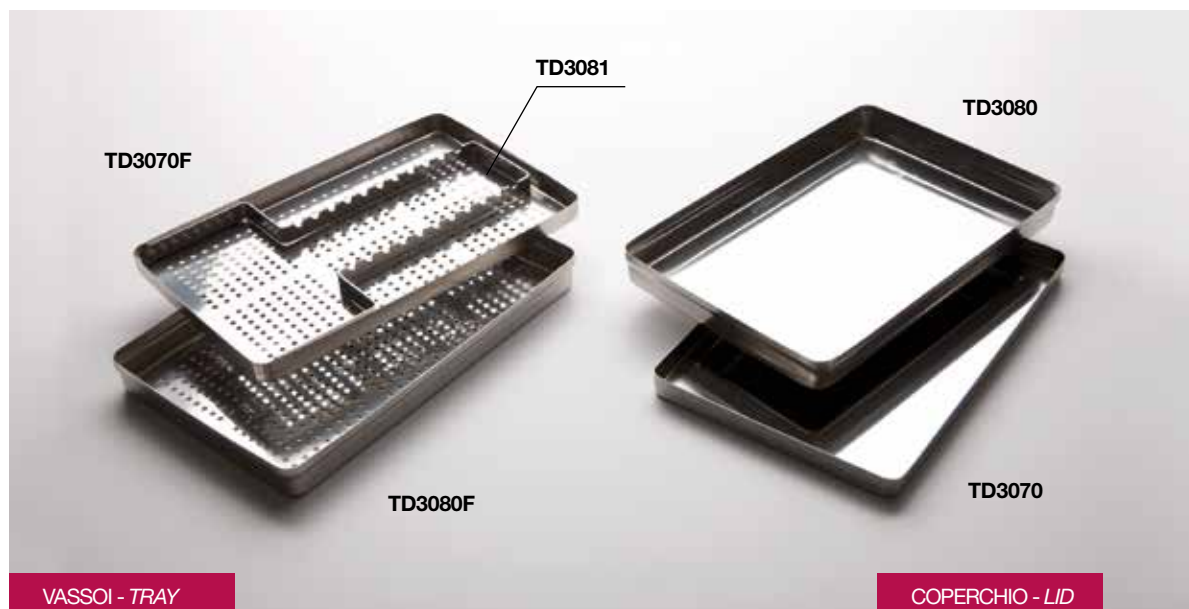

TD3070 vassoio inox liscio - *standard tray*
TD3070F vassoio inox forato - *perforated tray*
TD3081 rastrelliera inox MAXI 11 sedi
 - *insert frame 11 instruments*

mis. 284x183x17 mm

TD3080 coperchio inox liscio - *standard lid*
TD3080F coperchio inox forato - *perforated lid*

mis. 288x187x29 mm

VASSOI - TRAY

COPERCHIO - LID

VASSOI PORTASTRUMENTI MINI in acciaio inox

*Stainless steel mini
instrument tray*



VASSOI - TRAY

COPERCHIO - LID

TD3090 vassoio inox liscio - *standard tray*
TD3090F vassoio inox forato - *perforated tray*
TD3082 rastrelliera inox MINI 8 sedi
 - insert frame 8 instruments

mis. 183x140x17 mm

TD3091 coperchio inox liscio - *standard lid*
TD3091F coperchio inox forato - *perforated lid*

mis. 187x145x25 mm

VASCHETTE PORTASTRUMENTI in acciaio inox

*Stainless steel
instrument basin*



TD3071 MAXI - mis. 200x150 mm
TD3072 MINI - mis. 200x100 mm

BACINELLA INOX RENIFORME*Stainless steel kidney tray*

TD3085 cm 18
TD3086 cm 20,5
TD3087 cm 25,5

CASSETTA PORTASTRUMENTI CON FASCIA IN ACCIAIO INOX*Stainless steel box with band*

185x140x21 mm

TD3280 per una massima sterilizzazione - *for a complete sterilization*

CASSETTE PORTASTRUMENTI CON FASCIA in acciaio inox

Stainless steel box with band



CON FASCIA

TD3092 MINI - mis. 185x100x21 mm
TD3093 MAXI - mis. 280x185x21 mm

TD3094 MEDIO - mis. 185x140x21 mm
TD3099 MINI - mis. 140x100x21 mm



Possibilità di inserti colorati - *availability of coloured insert*

CASSETTE PORTASTRUMENTI CON CERNIERA in acciaio inox

*Stainless steel box
with hinge*

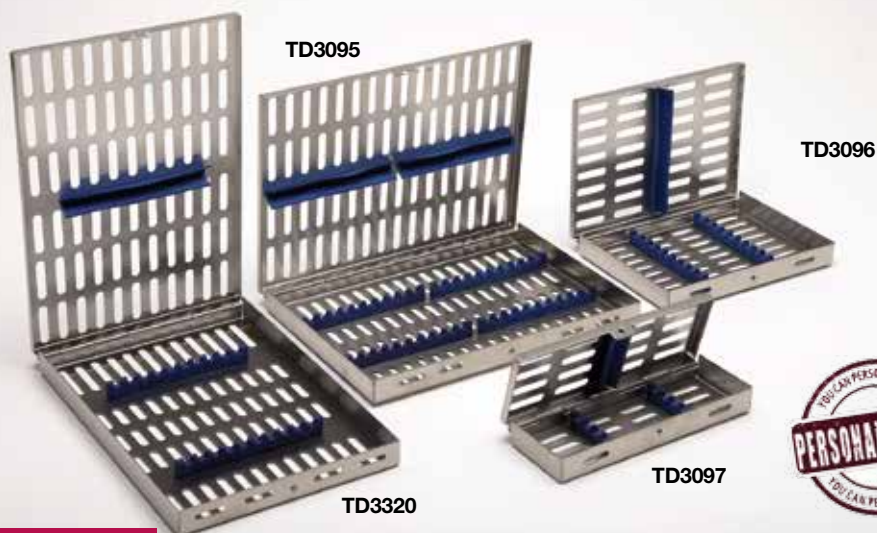

CON CERNIERA

TD3095 MAXI - mis. 250x180x22 mm
TD3096 MEDIO - mis. 180x125x22 mm

TD3097 MINI - mis. 180x65x22 mm
TD3320 MAXI - cerniera lato corto 250X170X22 mm



Possibilità di inserti colorati - *availability of coloured insert*

CASSETTE PORTAISTRUMENTI CON CLIP
in acciaio inox

*Stainless steel box
with clip*



TD3095 clip MAXI - mis. 250x180x22 mm
TD3096 clip MEDIO - mis. 180x125x22 mm

TD3097 clip MINI - mis. 180x65x22 mm



Possibilità di inserti colorati - *availability of coloured insert*

CASSETTE PORTAISTRUMENTI MAGNUM
in acciaio inox

*Stainless steel magnum box
with clip*



TD3098 MAGNUM - mis. 240x180x45 mm



L-3113BLU 10 PCS
L-3112BLU 8 PCS



L-3111BLU



L-3113GIA 10 PCS
L-3112GIA 8 PCS



L-3111GIA



L-3113ROS 10 PCS
L-3112ROS 8 PCS



L-3111ROS



L-3113VER 10 PCS
L-3112VER 8 PCS



L-3111VER

PORTA COTONE
in alluminio anodizzato

*Aluminium
cotton dispenser*



Ø 50 - h 70 mm

Ø 50 - h 40 mm

TD3250ROS rosso - red
TD3250BLU blu - blue
TD3250VER verde - green

TD3250ORO oro - gold
TD3250ARG argento - silver
TD3250BIA bianco - white

TD3265 argento - silver

PORTA RIFIUTI
in alluminio anodizzato

*Aluminium waste
container*



Ø 65 - h 70 mm

Ø 50 - h 40 mm

TD3240ROS rosso - red
TD3240BLU blu - blue
TD3240VER verde - green

TD3240ORO oro - gold
TD3240ARG argento - silver
TD3240BIA bianco - white

TD3260 argento - silver

SUPPORTO UNIVERSALE
in acciaio inox

Stainless steel universal holders

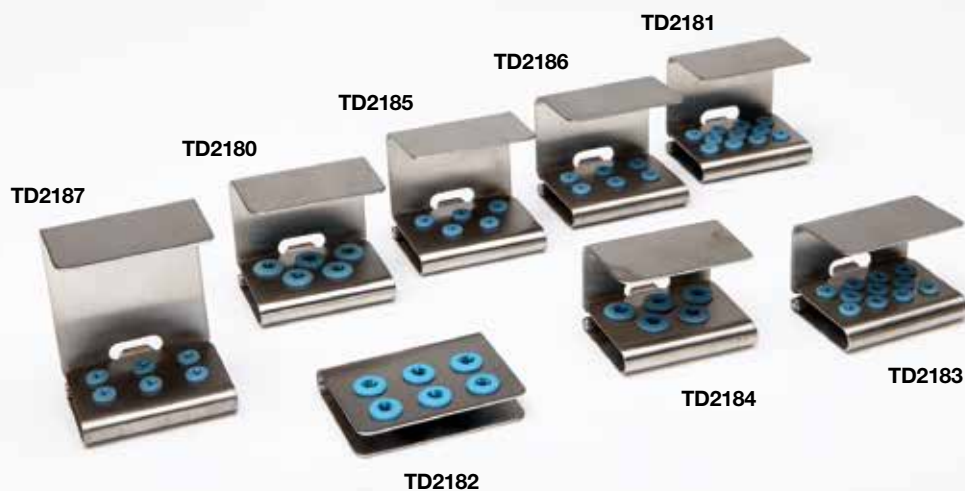

TD2180 con clip h 45 mm - 5 fori grandi Ø 5 mm
TD2181 con clip h 45 mm 11 fori piccoli Ø 2 mm
TD2182 6 fori grandi Ø 5 mm
TD2183 con clip h 35 mm - 11 fori piccoli Ø 2 mm

TD2184 con clip h 35 mm - 5 fori grandi Ø 5 mm
TD2185 con clip h 45 mm - 5 fori piccoli Ø 2 mm
TD2186 con clip h 45 mm - 6 fori piccoli Ø 2 mm
TD2187 con clip h 65 mm - 6 fori piccoli Ø 2 mm

SUPPORTO UNIVERSALE
in plastica autoclavabile

Universal holder made of autoclavable plastic



64x46xh37 mm

autoclavabile 121°

TD2195
TD2196

base nera inserti blu - *black tray blue inserts*
 base grigia inserti rossi - *grey tray red inserts*

KIT PER IMPLANTOLOGIA*Kit for implantology***TD3371****KIT PER IMPLANTOLOGIA
in acciaio inox satinato***Kit for implantology***TD3372**

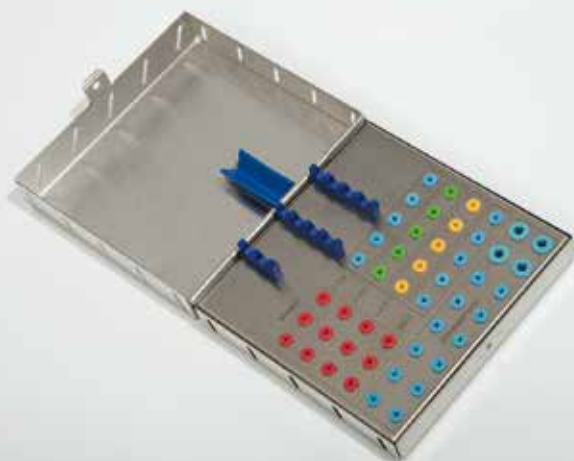

145x145x46 mm

TD3350

Kit per implantologia in acciaio inox, con inserti di diverse misure, con posizionamento speciale per strumenti

Stainless steel kit for implantology, with inserts of different measures, with placement for instruments

BOX MEDIO PER IMPLANTOLOGIA*Medium box for implantology*

117x82x48 mm

TD3370

Box medio per implantologia con inserti

Medium box for implantology with inserts

KIT PER IMPLANTOLOGIA

Kit for implantology

150x180x55 mm

TD3360 alloggiamento strumenti per implantologia - *place for implantology instruments*

KIT PER IMPLANTOLOGIA

Kit for implantology

150x100x40 mm

TD3385 34 inserti per 2,35 + alloggiamento cricchetto - *34 insert for 2,35+ place for dental ratchet*



L-3107



L-3114



L-3110



L-3107ROS



L-3114ROS



L-3110ROS



L-3107GIA



L-3114GIA



L-3107VER



L-3115



L-3116

PROGETTAZIONE SU MISURA

*We design and manufacture
personalized new projects*

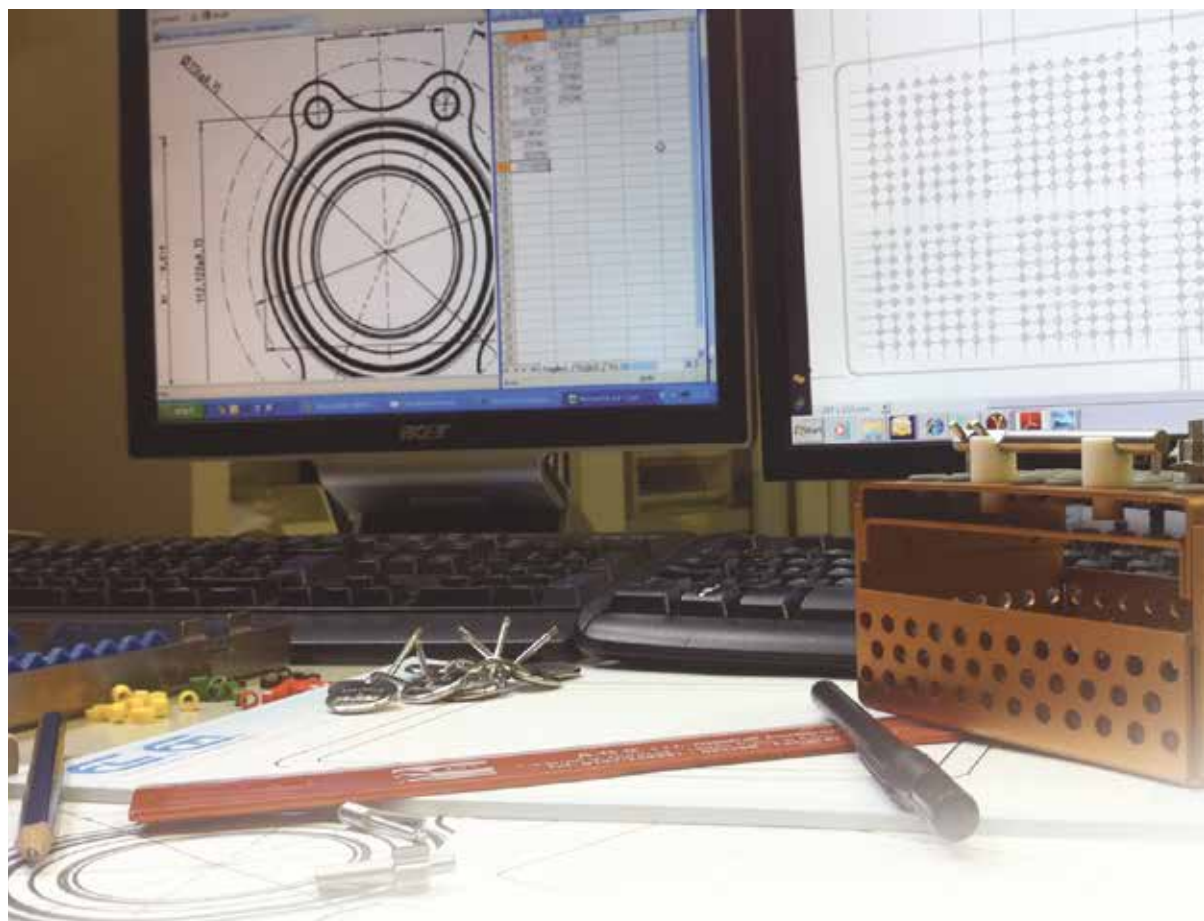

*Progettiamo e realizziamo
articoli su misura*

*On demand your articles
in private label*





PORTAIMPRONTE
IMPRESSION TRAYS

PORTAIMPRONTE IN ACCIAIO INOX
Stainless steel impression trays



Portaimpronte non forate in acciaio inox,
senza bordino ritentivo
Solid Stainless steel impression trays
without retention rim



Serie Maxi ▼



TD0048 Serie Maxi da 12 pezzi
Maxi set of 12 pieces

Serie Mini ▼

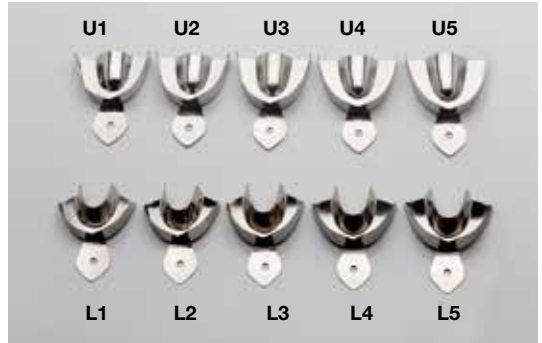

TD0049 Serie Mini da 10 pezzi
Mini set of 10 pieces



TD 0050 TD 0051 TD 0052 TD 0053 TD 0054 TD 0055

66	67	68	72	73	74
50	51	55	56	59	64



Misure
Sizes



TD 0060 TD 0061 TD 0062 TD 0063 TD 0064 TD 0065

68	70	72	78	79	80
52	54	56	57	59	63



Misure
Sizes



TD 0075 TD 0071 TD 0076 TD 0072 TD 0077 TD 0073

◀ **Portaimpronte parziali per ponti e corone**
Impression trays for crown and bridge-work

PORTAIMPRONTE IN ACCIAIO INOX
Stainless steel impression trays



Portaimpronte forate in acciaio inox, ▲
senza bordino ritentivo
Perforated Stainless steel impression tray
without retention rim

Serie Maxi ▼

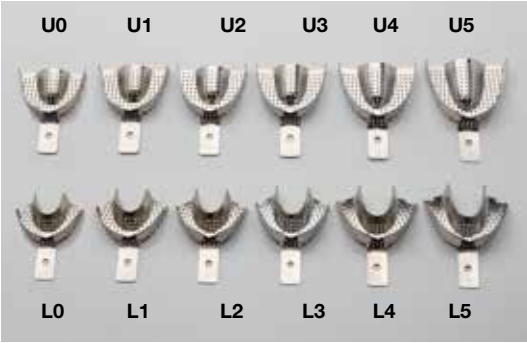

TD0098 Serie Maxi da 12 pezzi
Maxi set of 12 pieces

Serie Mini ▼

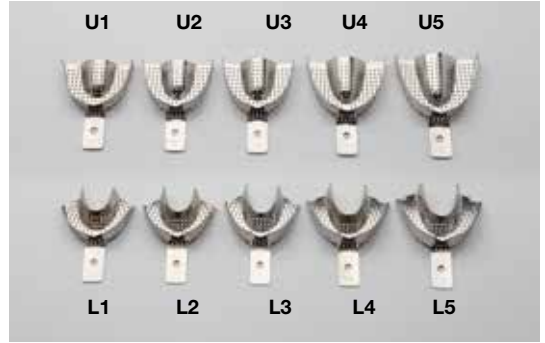

TD0099 Serie Mini da 10 pezzi
Mini set of 10 pieces



TD 0100 TD 0101 TD 0102 TD 0103 TD 0104 TD 0105

66	67	68	72	73	74
50	51	55	56	59	64



Misure
Sizes



TD 0110 TD 0111 TD 0112 TD 0113 TD 0114 TD 0115

68	70	72	78	79	80
52	54	56	57	59	63



Misure
Sizes



TD 0125 TD 0121 TD 0126 TD 0122 TD 0127 TD 0123

◀ **Portaimpronte parziali per ponti e corone**
Impression trays for crown and bridge-work

PORTAIMPRONTE IN ACCIAIO INOX
Stainless steel impression trays



Portaimpronte forate in acciaio inox,
con bordino ritentivo ▲
Perforated Stainless steel impression
trays with retention rim

Serie Maxi ▼



TD0128 Serie Maxi da 12 pezzi
Maxi set of 12 pieces

Serie Mini ▼



TD0129 Serie Mini da 10 pezzi
Mini set of 10 pieces



TD 0130 TD 0131 TD 0132 TD 0133 TD 0134 TD 0135

66	67	68	72	73	74
50	51	55	56	59	64



Misure
Sizes



TD 0140 TD 0141 TD 0142 TD 0143 TD 0144 TD 0145

68	70	72	78	79	80
52	54	56	57	59	63



Misure
Sizes



TD 0176D TD 0176A TD 0176E TD 0176B TD 0176F TD 0176C

◀ **Portaimpronte parziali per ponti e corone**
Impression trays for crown and bridge-work

PORTAIMPRONTE IN ACCIAIO INOX*Stainless steel impression trays*

Portaimpronte non forate in acciaio inox, ▲
con bordino ritentivo

Solid Stainless steel impression tray with
retention rim

Serie Maxi ▼

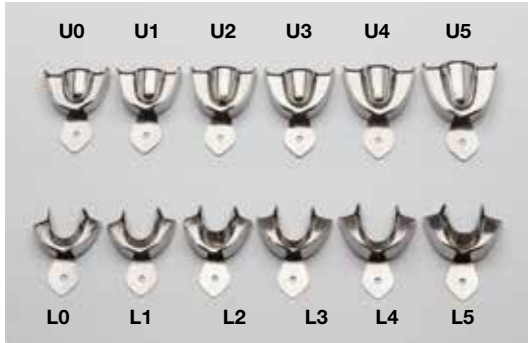

TD0158 Serie Maxi da 12 pezzi
Maxi set of 12 pieces

Serie Mini ▼



TD0159 Serie Mini da 10 pezzi
Mini set of 10 pieces



TD 0160 TD 0161 TD 0162 TD 0163 TD 0164 TD 0165

66	67	68	72	73	74
50	51	55	56	59	64

Misure
Sizes



TD 0170 TD 0171 TD 0172 TD 0173 TD 0174 TD 0175

68	70	72	78	79	80
52	54	56	57	59	63

Misure
Sizes



TD 0176P TD 0176M TD 0176Q TD 0176N TD 0176R TD 0176O

◀ **Portaimpronte parziali per ponti e corone**
Impression trays for crown and bridge-work

PORTAIMPRONTE IN ACCIAIO INOX
Stainless steel impression trays



Portaimpronte forate in acciaio inox “ANATOMIC”,
senza bordino ritentivo ▲
“ANATOMIC” perforated Stainless steel impression trays
without retention rim

Serie Maxi ▼



TD0177A Serie Maxi da 12 pezzi
Maxi set of 12 pieces

Serie Mini ▼



TD0177B Serie Mini da 10 pezzi
Mini set of 10 pieces



TD 0177C TD 0177D TD 0177E TD 0177F TD 0177G TD 0177H

61	64	66	69	71	73	
47	51	53	57	60	62	

Misure
Sizes



TD 0177I TD 0177L TD 0177M TD 0177N TD 0177O TD 0177P

55	60	72	74	76	78	
47	49	54	57	59	61	

Misure
Sizes

PORTAIMPRONTE IN ACCIAIO INOX
Stainless steel impression trays



Portaimpronte non forate in acciaio inox "ANATOMIC", ▲
senza bordino ritentivo
"Anatomic" solid Stainless steel impression tray
without retention rim

Serie Maxi ▼



TD0178A Serie Maxi da 12 pezzi
Maxi set of 12 pieces

Serie Mini ▼



TD0178B Serie Mini da 10 pezzi
Mini set of 10 pieces



TD0178C TD0178D TD0178E TD0178F TD0178G TD0178H

61	64	66	69	71	73
47	51	53	57	60	62



Misure
Sizes



TD0178I TD0178L TD0178M TD0178N TD0178O TD0178P

55	60	72	74	76	78
47	49	54	57	59	61



Misure
Sizes

PORTAIMPRONTE IN ALLUMINIO
aluminium impression trays



Portaimpronte forate in alluminio, senza bordino ritentivo
Perforated aluminium impression trays without retention rim



Serie Maxi ▼

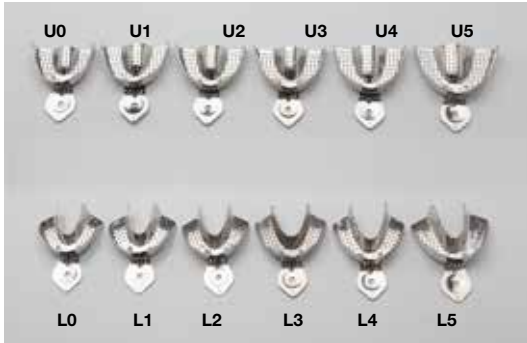

TD0198

Serie Maxi da 12 pezzi
Maxi set of 12 pieces

Serie Mini ▼



TD0199

Serie Mini da 10 pezzi
Mini set of 10 pieces



TD0200 TD0201 TD0202 TD0203 TD0204 TD0205

63	69	72	74	75	83
44	47	48	50	53	58



Misure
Sizes



TD0210 TD0211 TD0212 TD0213 TD0214 TD0215

66	69	71	73	75	78
55	56	57	58	62	64



Misure
Sizes



TD0225 TD0221 TD0226 TD0222 TD0227 TD0223

PORTAIMPRONTE RYLSAN
rylsan impression trays



Portaimpronte Rylsan forate colorate
Disponibili anche bianche
Perforated coloured Rylsan impression trays
Available also in white



Serie Maxi ▼

Serie Mini ▼



TD0278

Serie Maxi da 12 pezzi
Maxi set of 12 pieces

TD0279

Serie Mini da 10 pezzi
Mini set of 10 pieces



TD0280 TD0281 TD0282 TD0283 TD0284 TD0285

63	69	72	74	75	83
44	47	48	50	53	58



Misure
Sizes



TD0290 TD0291 TD0292 TD0293 TD0294 TD0295

66	69	71	73	75	78
55	56	57	58	62	64



Misure
Sizes

PORTAIMPRONTE PER EDENTULI

complete denture impression trays



Portaimpronte non forate in acciaio inox
per protesi dentali

Solid complete denture Stainless steel
impression trays

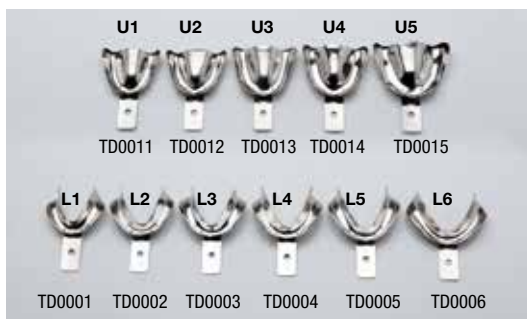

TD0000 Serie da 11 pezzi
Set of 11 pieces

	TD0011	TD0012	TD0013	TD0014	TD0015		
	60	63	68	69	78		
	51	52	58	59	63		
	TD0001	TD0002	TD0003	TD0004	TD0005	TD0006	
	60	67	70	74	75	79	
	51	52	54	55	55	56	

PORTAIMPRONTE PER EDENTULI



complete denture impression trays



Portaimpronte forate in acciaio inox
per protesi dentali
Perforated-complete denture Stainless steel
impression trays



TD0020 Serie da 11 pezzi
Set of 11 pieces

	TD0031	TD0032	TD0033	TD0034	TD0035		
	60	63	68	69	78	 Misure Sizes	
	51	52	58	59	63		
	TD0021	TD0022	TD0023	TD0024	TD0025	TD0026	
	60	67	70	74	75	79	 Misure Sizes
	51	52	54	55	55	56	

PORTAIMPRONTE PER EDENTULI
complete denture impression trays



Portaimpronte forate in acciaio inox
per protesi dentali
 Perforated complete denture Stainless steel
 impression trays



TD0180 Serie da 6 pezzi
 Set of 6 pieces

TD0181	TD0182	TD0183		Misure Sizes
78	82	83		
57	62	63		Misure Sizes
TD0185	TD0186	TD0187		
75	76	77		
62	63	67		

PORTAIMPRONTE PER EDENTULI IN POLICARBONATO

complete denture polycarbonate impression trays



Portaimpronte in polycarbonato autoclavabili (a 134°C) studiate per bocche edentule o parzialmente dentate.

Polycarbonate autoclavable (at 134°) perforated impression trays for edentulous or partially toothed bites.



TD 0300

Set di 24 pezzi - *set of 24 pieces*

U1, U2, U3, U4, U5, U6, U7

L1, L2, L3, L4, L5, L6, L7, L8, L9, L10, L11, L12, L13

U1P, U2P, L1C, L2C

Con compasso - *with compass*

TD 0301

Set di 7 pezzi - *set of 7 pieces*

U1, U2, U3, U4, U5, U6, U7

TD 0302

Set di 13 pezzi - *set of 13 pieces*

L1, L2, L3, L4, L5, L6, L7, L8, L9, L10, L11, L12, L13

TD 0303

Set di 4 pezzi - *set of 4 pieces*

U1P, U2P, L1C, L2C

PORTAIMPRONTE PER BOCCHE DENTATE IN POLICARBONATO AUTOCLAVABILE

standard polycarbonate autoclavable impression trays



Portaimpronte in policarbonato autoclavabili
(a 134°) per bocche dentale
Standard polycarbonate autoclavable
(at 134°) impression trays



TD0350

Serie da 12 pezzi
Set of 12 pieces

U1, U2, U3, U4,
L1, L2, L3, L4



PORTAIMPRONTE MONOUSO IN POLIESTERE
disposable polyester impression trays



Portaimpronte monouso in poliestere
Disposable polyester impression trays

Kit 24 pcs

TD0361	L1	TD0371	U1
TD0362	L2	TD0372	U2
TD0363	L3	TD0373	U3
TD0364	L4	TD0374	U4

TD0365	parziale destro L1 - <i>L1 partial right</i>
TD0366	parziale sinistro L1 - <i>L1 partial left</i>
TD0367	parziale destro L2 - <i>L2 partial right</i>
TD0368	parziale sinistro L2 - <i>L2 partial left</i>



STRUMENTI MANICO LISCIO

ACCIAIO INOX

INSTRUMENTS WITH SMOOTH HANDLE

STAINLESS STEEL

SONDE INOX MANICO LISCIO
Stainless steel Explorers with smooth handle

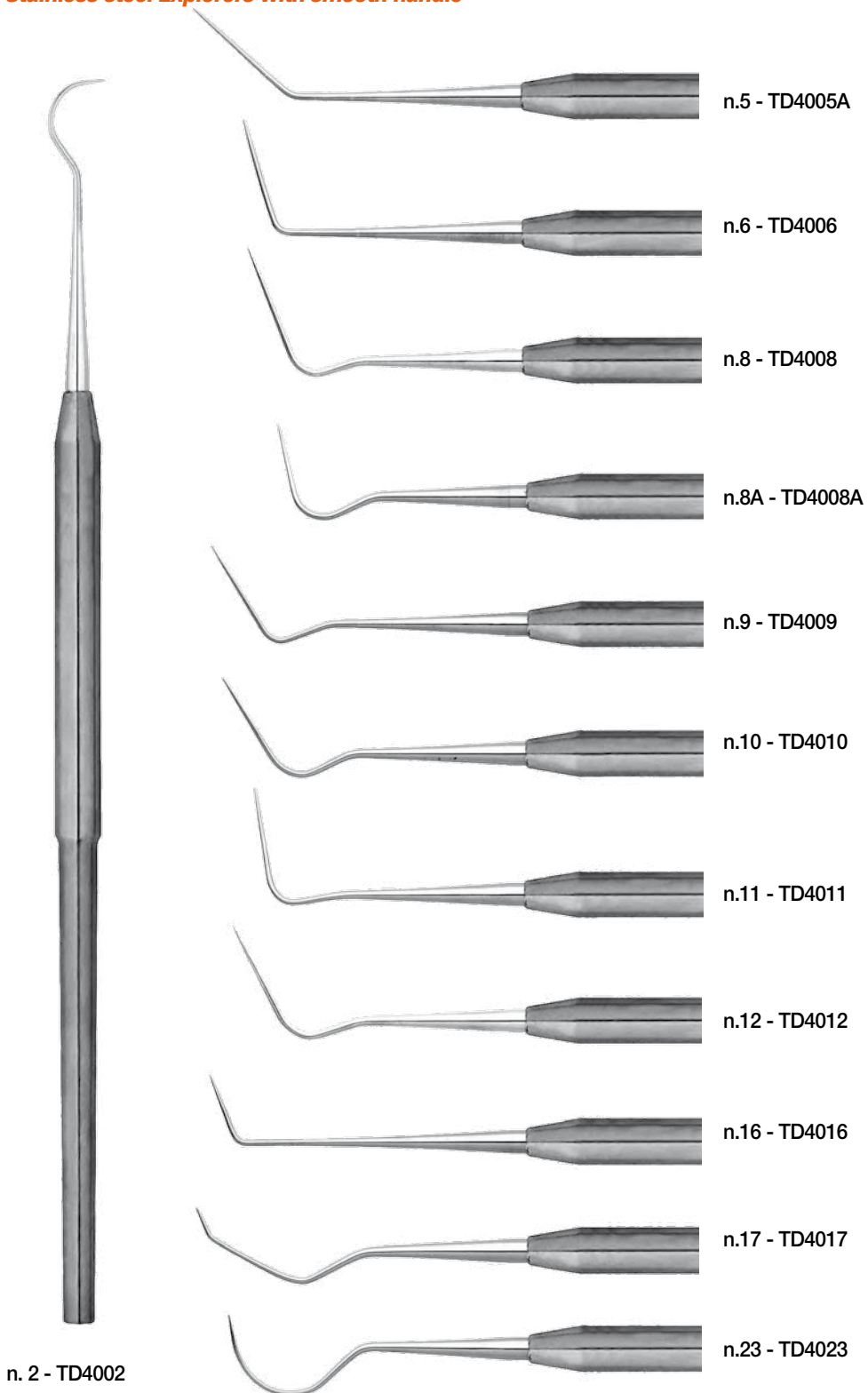

SONDE INOX DOPPIE MANICO LISCIO
Stainless steel double-ended Explorers with smooth handle

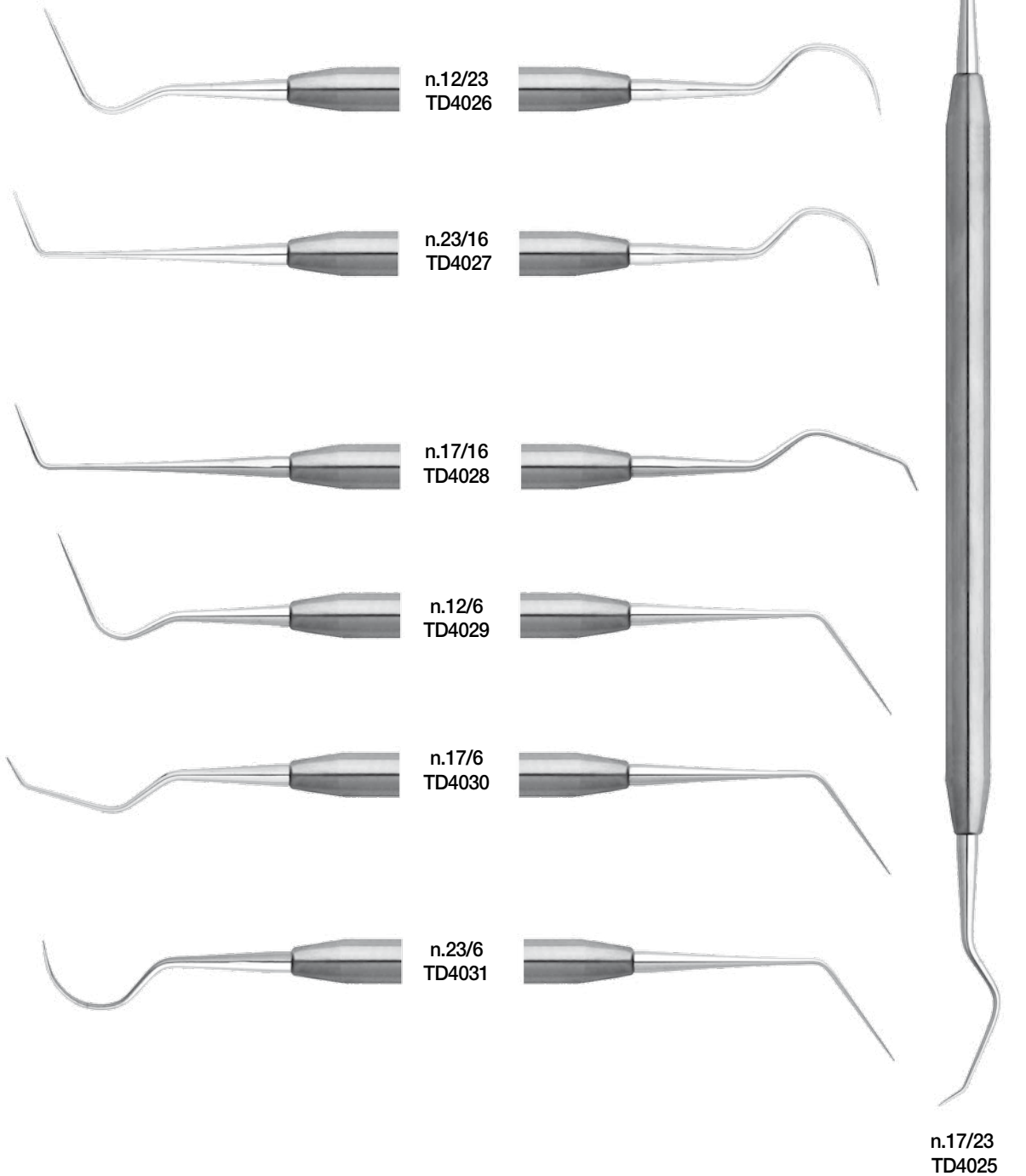

SONDE INOX MILLIMETRICHE PARODONTALI CON MANICO LISCIO LASER SYSTEM

Stainless steel periodontal pocket probes with smooth handle laser system

LASER SYSTEM



Williams
TD4101



Merritt A - TD4102

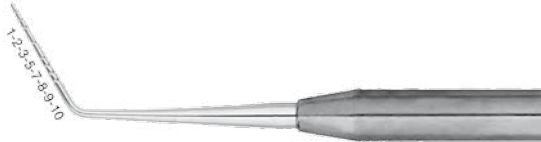

Merritt B - TD4103



Goldman Fox - TD4104



University of Michigan - TD4105

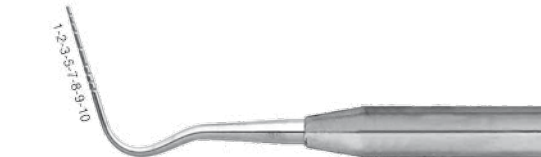

n.26G - TD4106

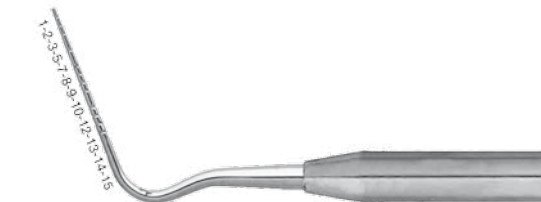

n.26G/ A - TD4107

**SONDE INOX MILLIMETRICHE PARODONTALI
CON MANICO LISCIO LASER SYSTEM**
Stainless steel periodontal pocket probes with smooth handle laser system

LASER SYSTEM



TD4107ACP15
n° 26G/A CP15
Laser system



TD4108ACP15
CP15
Laser system



TD4108
CP12
Laser system



TD4109
CP11
Laser system



TD4110
CP12
Laser system



TD4110C
CPC
Laser system



TD4110S
CP12S
Laser system

SONDE INOX MILLIMETRICHE PARODONTALI DOPPIE CON MANICO LISCI

Stainless steel periodontal pocket probes double-ended with smooth handle

LASER SYSTEM

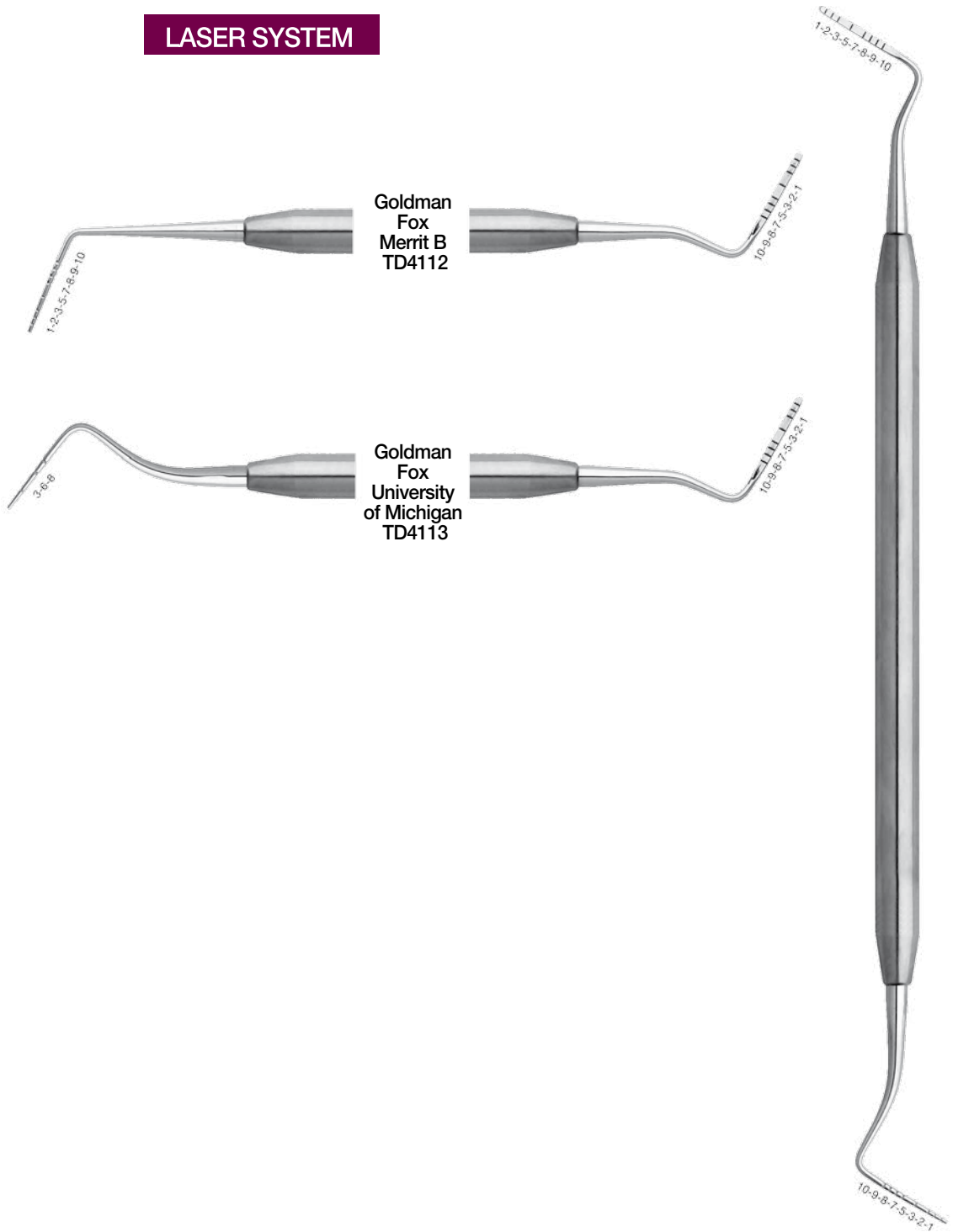

Goldman Fox Williams
TD4111

COMBINAZIONE SONDE/ SONDE MILLIMETRICHE CON MANICO LISCIO

Stainless steel combination Explorers-probes with smooth handle

LASER SYSTEM

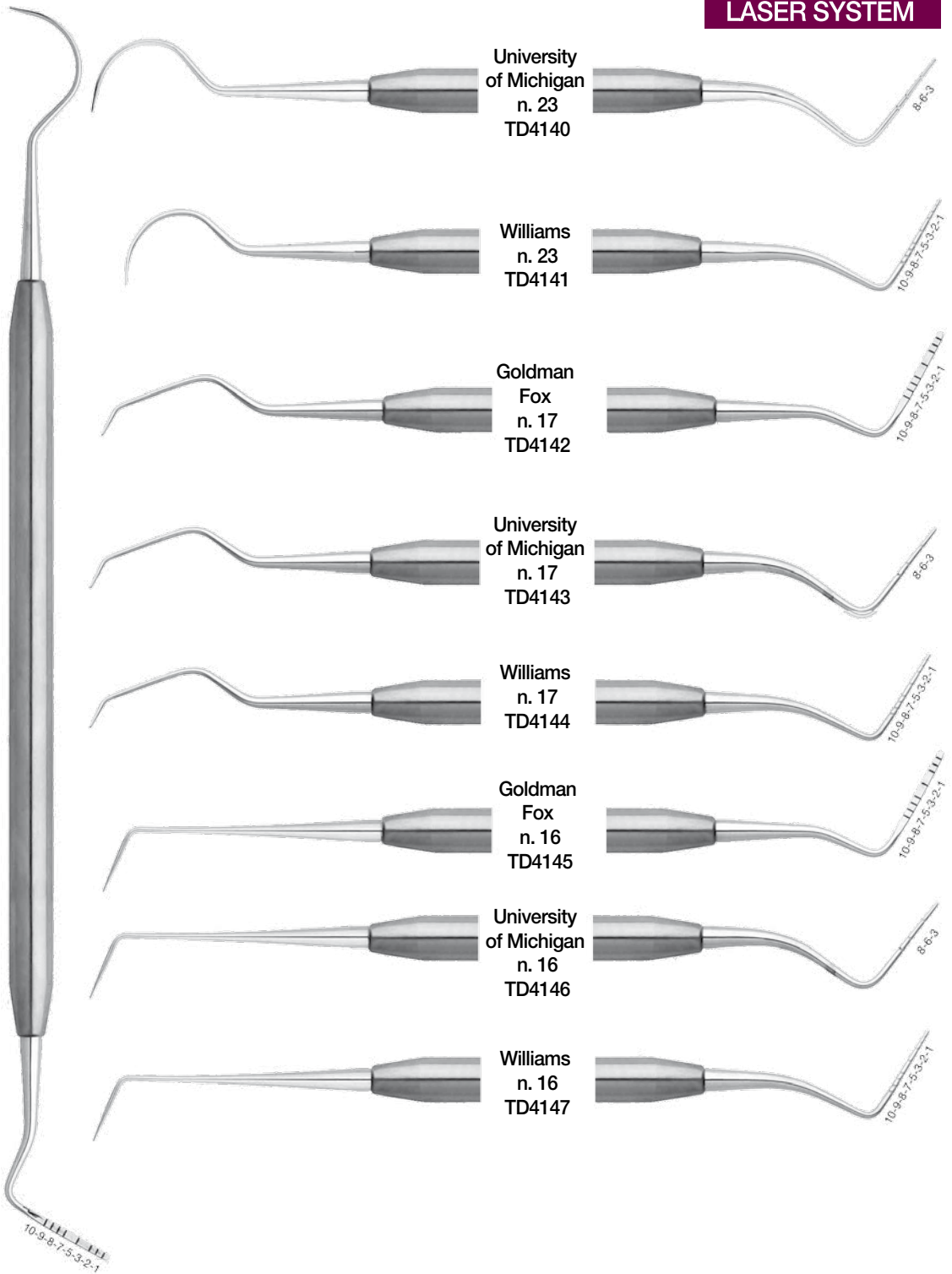

University
of Michigan
n. 23
TD4140

Williams
n. 23
TD4141

Goldman
Fox
n. 17
TD4142

University
of Michigan
n. 17
TD4143

Williams
n. 17
TD4144

Goldman
Fox
n. 16
TD4145

University
of Michigan
n. 16
TD4146

Williams
n. 16
TD4147

Goldman Fox n. 23
TD4139

STRUMENTI INOX PER TRATTAMENTI CANALARI CON MANICO LISCIO

Stainless steel endodontic instruments with smooth handle

Luks Ø 0,7
TD4152/A



Luks Ø 0,9
TD4153/A



Luks Ø 1,1
TD4154/A

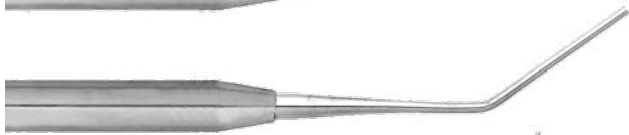

Vertical Condenser
Ø 0,6
TD4151

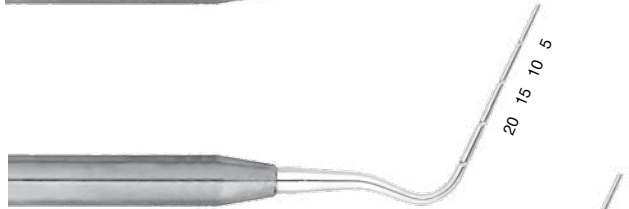

Vertical Condenser
Ø 0,7
TD4152

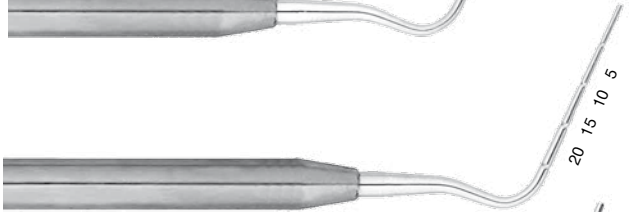

Vertical Condenser
Ø 0,9
TD4153



Vertical Condenser
Ø 1,1
TD4154



TD5150
piastra millimetrata
measuring plate



Luks Ø 0,6
TD4151/A

STRUMENTI INOX PER TRATTAMENTI CANALARI CON MANICO LISCIO

Stainless steel endodontic instruments with smooth handle

Spreader
TD4131

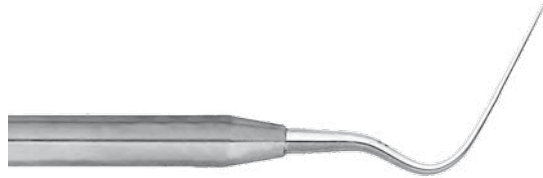

Spreader
TD4132

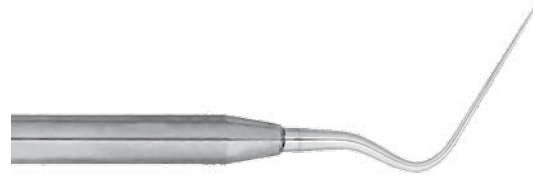

Spreader
TD4133

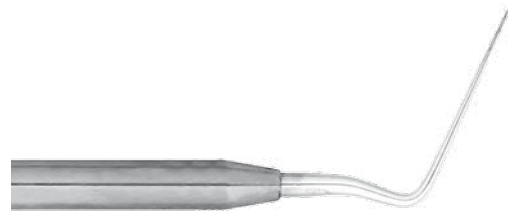

Spreader
TD4134

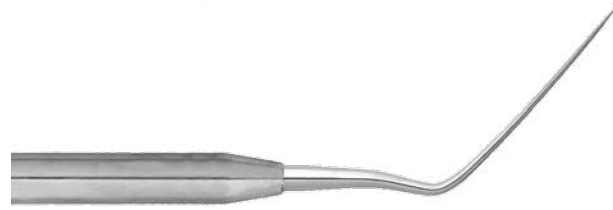

Spreader
TD4135

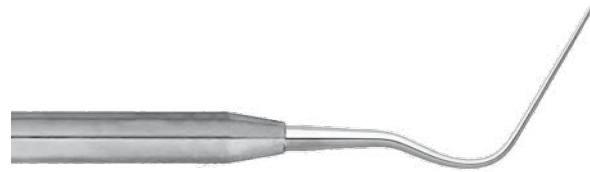

Spreader
TD4136

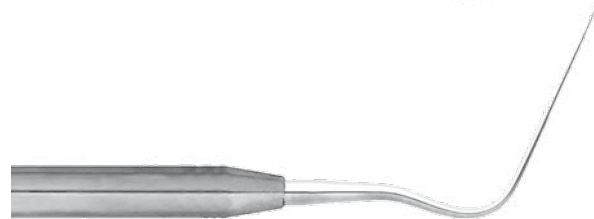

Spreader
TD4137

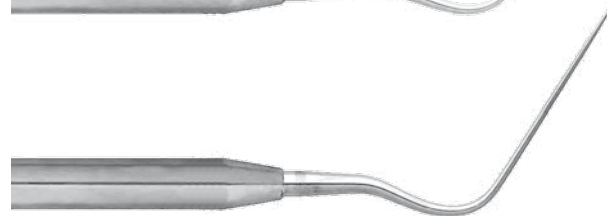

SPATOLE HEIDEMANN INOX CON MANICO LISCIO
Stainless steel Heidemann separating spatulas



n. 1
TD4171

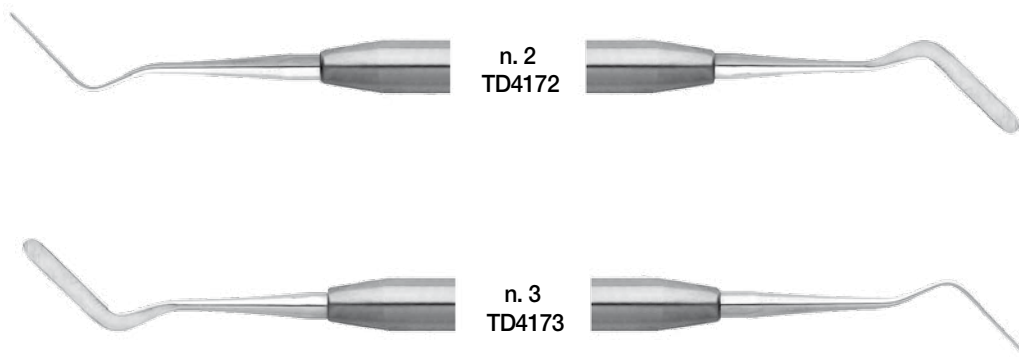

n. 2
TD4172

n. 3
TD4173

OTTURATORI INOX CON MANICO LISCIO

Stainless steel filling instruments with smooth handle



Westcott n. 1
TD4069

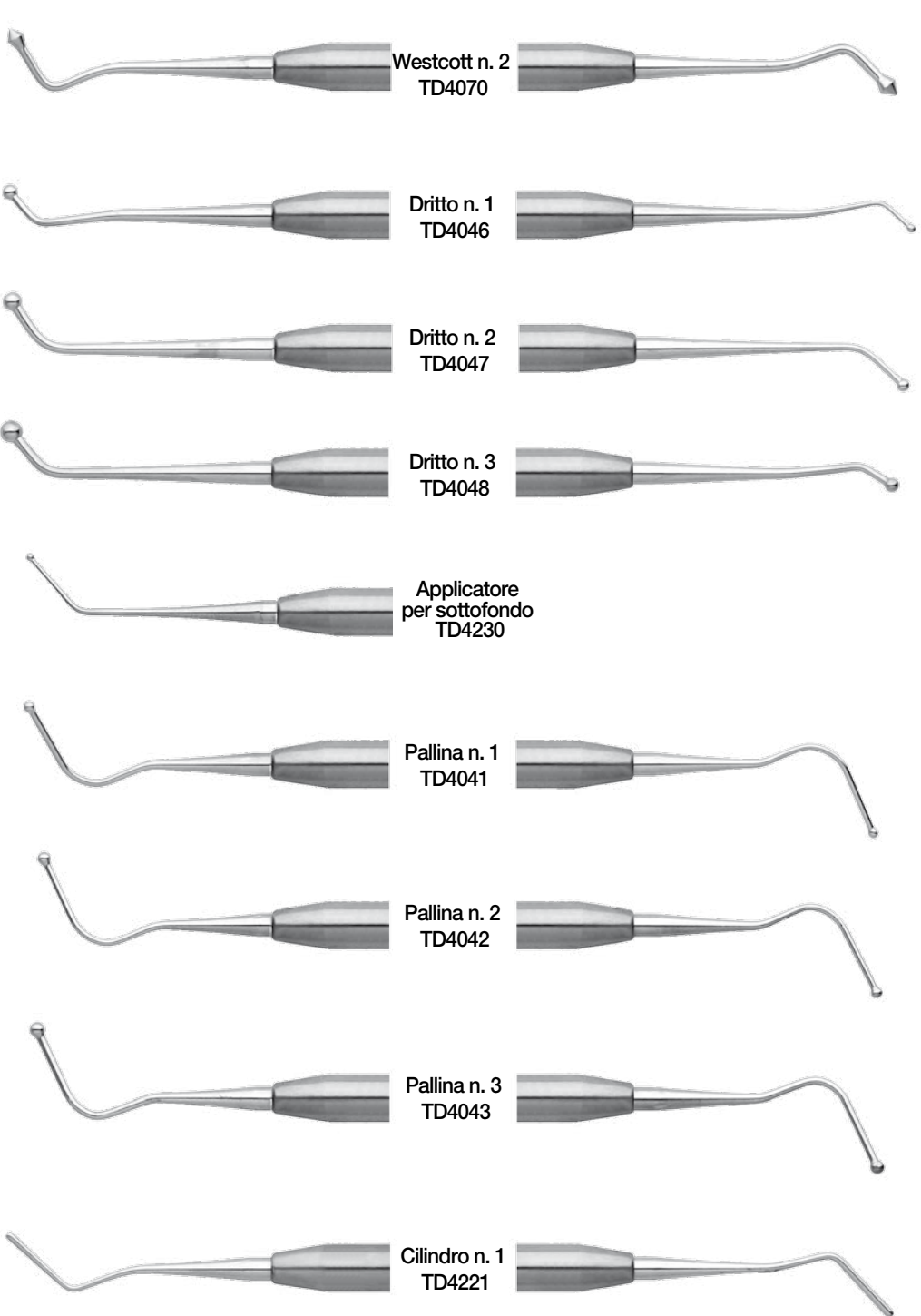

Westcott n. 2
TD4070

Dritto n. 1
TD4046

Dritto n. 2
TD4047

Dritto n. 3
TD4048

Applicatore
per sottofondo
TD4230

Pallina n. 1
TD4041

Pallina n. 2
TD4042

Pallina n. 3
TD4043

Cilindro n. 1
TD4221

OTTURATORI INOX CON MANICO LISCIO

Stainless steel filling instruments with smooth handle

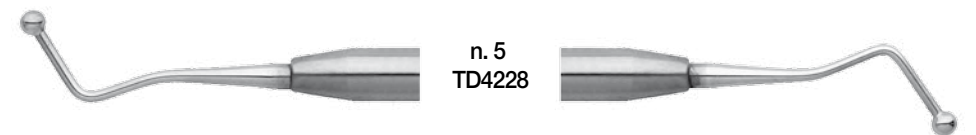
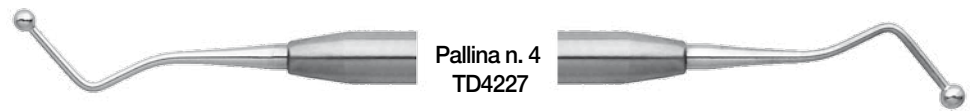
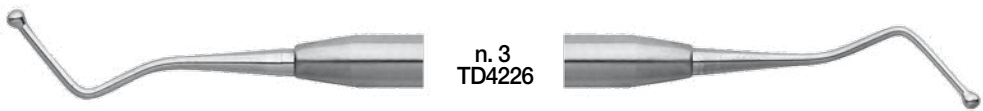
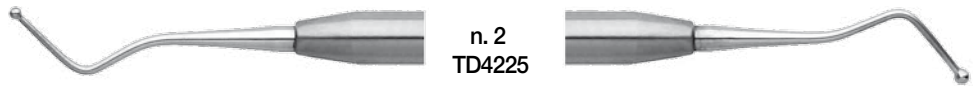
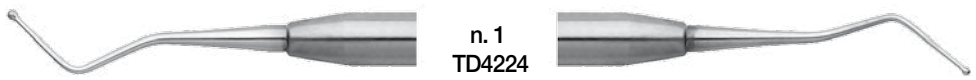
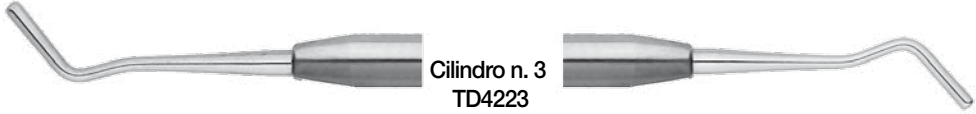

OTTURATORI INOX CON MANICO LISCIO

Stainless steel filling instruments with smooth handle



Piatto n. 2
TD4237



Piatto n. 3
TD4238



Piatto n. 4
TD4239



n. 1
Campana
TD4232



n. 2
Campana
TD4233



Piatto n. 1
TD4240



n. 2 Piatto
TD4241



n. 3 Piatto
TD4242

STRUMENTI INOX PER OTTURAZIONI PLASTICHE CON MANICO LISCIO

Stainless steel plastic filling instruments with smooth handle

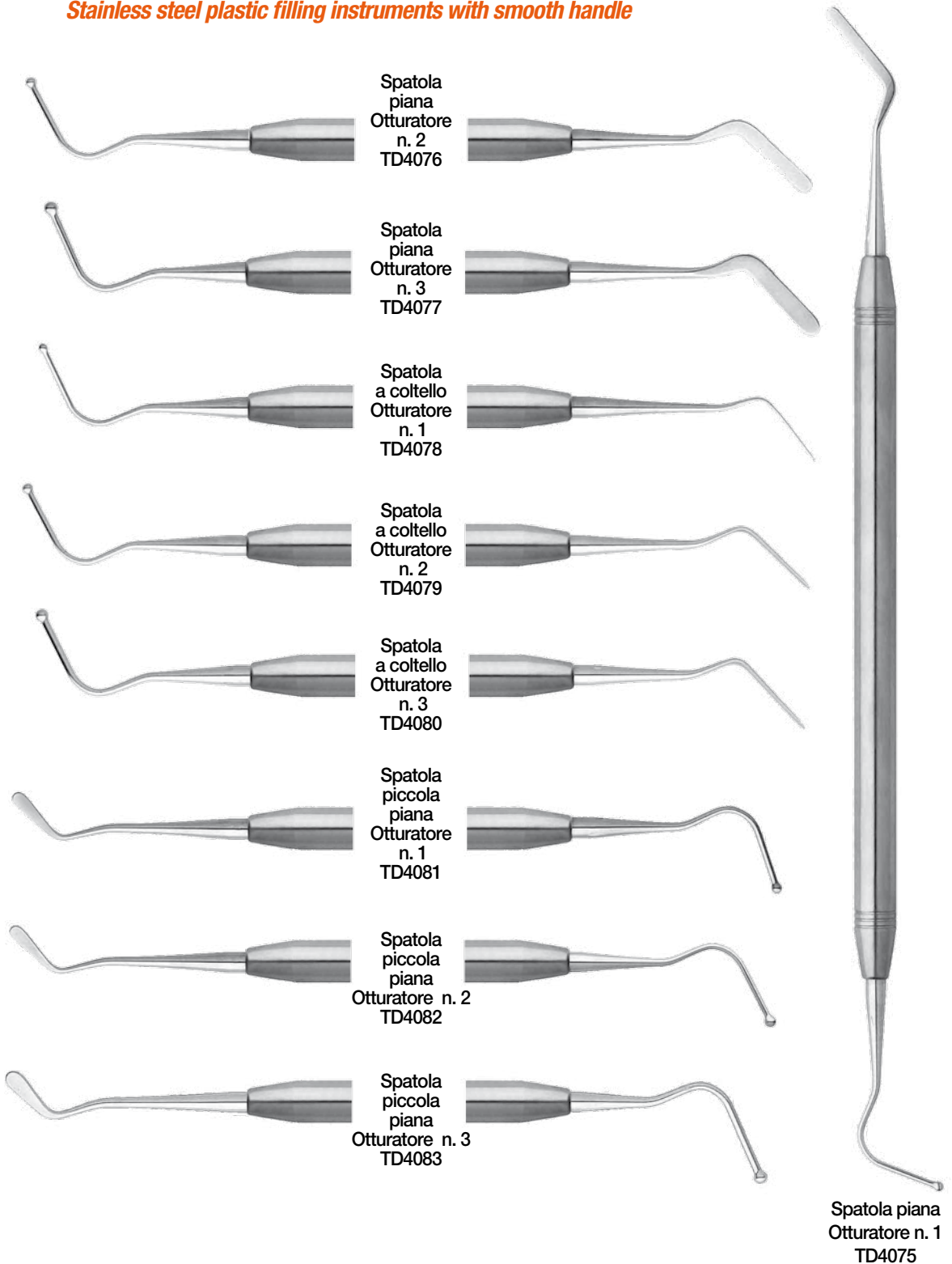

STRUMENTI INOX PER OTTURAZIONI PLASTICHE CON MANICO LISCIO

Stainless steel plastic filling instruments with smooth handle



Spatola
piccola
Coltello
Otturatore n. 1
TD4084



Spatola
piccola
Coltello
Otturatore n. 2
TD4085



Spatola
piccola
Coltello
Otturatore n. 3
TD4086



Applicatore
sottofondo
Spatola
piccola
piana n. 1
TD4088



Applicatore
sottofondo
Spatola
piccola
Coltello n. 1
TD4087



Otturatore
dritto
Spatola
piccola
piana n. 1
TD4089

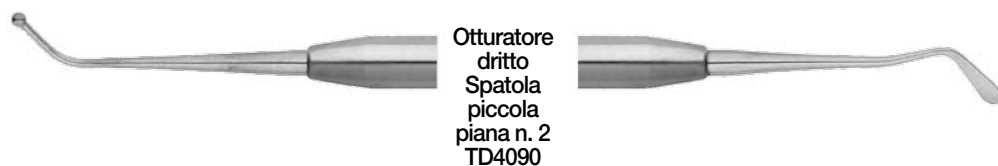

Otturatore
dritto
Spatola
piccola
piana n. 2
TD4090



Otturatore
dritto
Spatola
piccola
piana n. 3
TD4091

STRUMENTI INOX PER OTTURAZIONI PLASTICHE CON MANICO LISCIO

Stainless steel plastic filling instruments with smooth handle

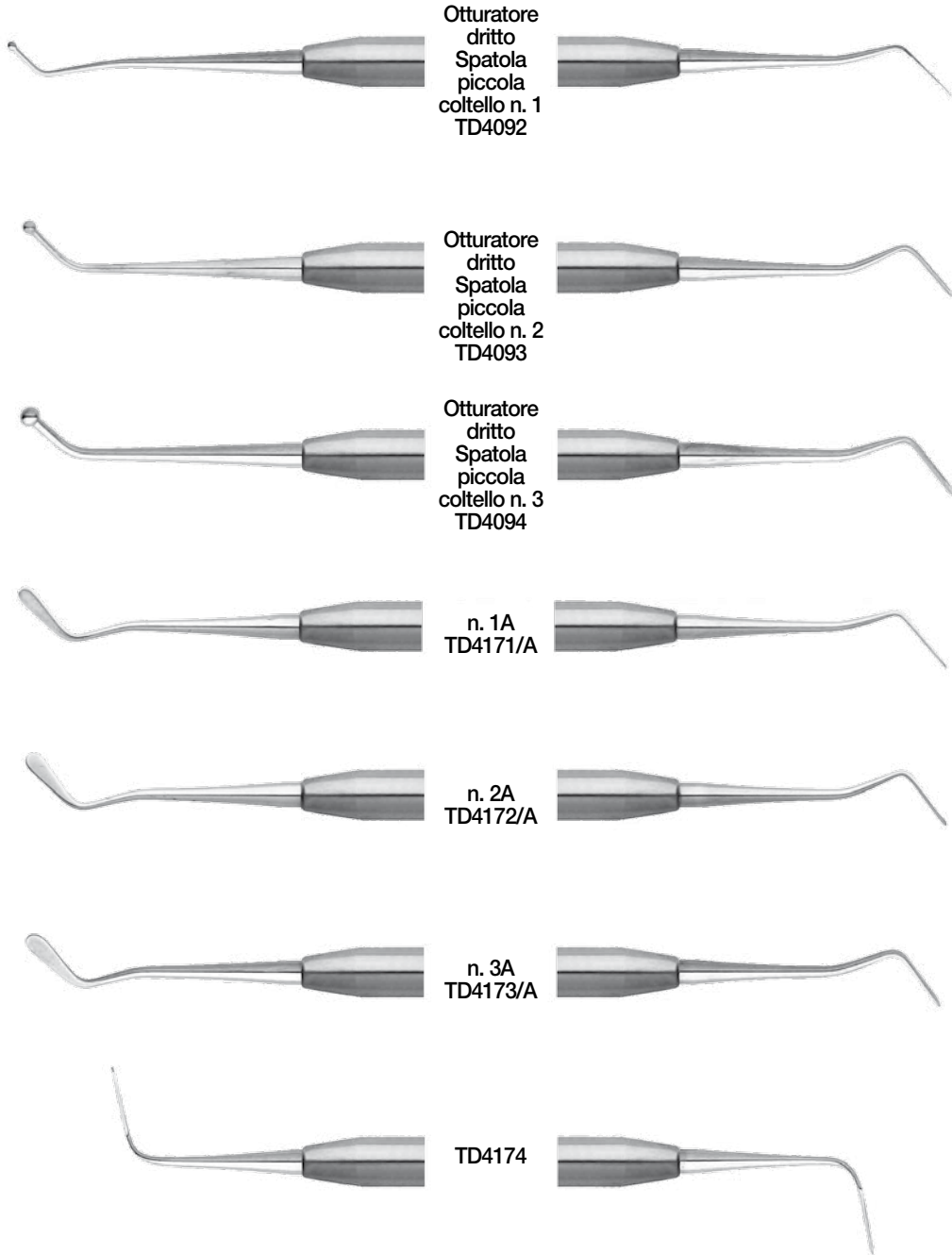

ESCAVATORI INOX CON MANICO LISCIO

Stainless steel excavator with smooth handle



n. 0
TD4190

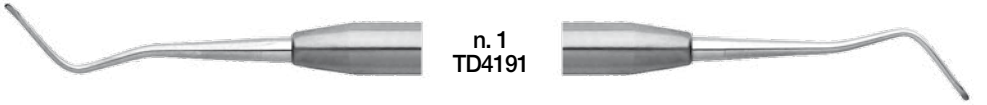

n. 1
TD4191

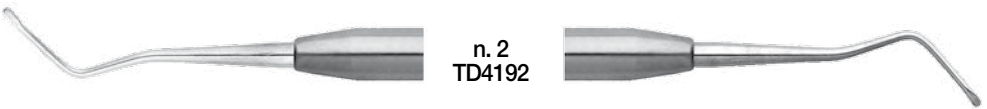

n. 2
TD4192

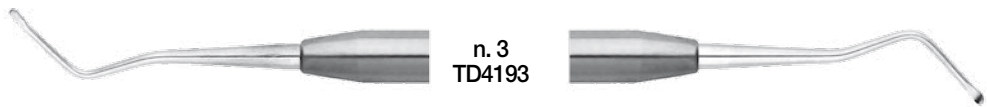

n. 3
TD4193

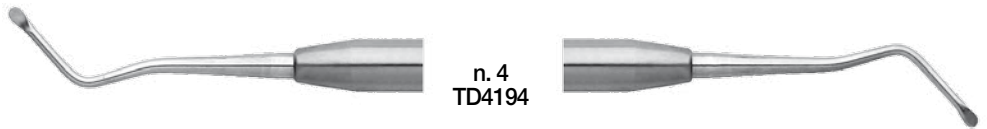

n. 4
TD4194



STRUMENTI MANICO ANATOMICO

ACCIAIO INOX

INSTRUMENTS WITH ANATOMIC HANDLE

STAINLESS STEEL

SONDE INOX CON MANICO ANATOMICO

Stainless steel Explorers with anatomic handle



n. 2
TD5002



n. 5
TD5005

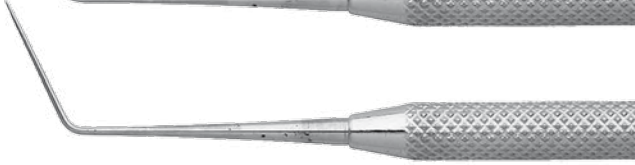

n. 6
TD5006



n. 8
TD5008



n. 8A
TD5008/A

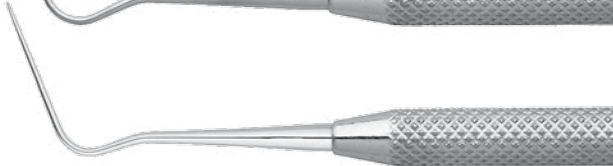

n. 9
TD5009



n. 10
TD5010



n. 11
TD5011



n. 12
TD5012



n. 16
TD5016



n. 17
TD5017



n. 23
TD5023

SONDE INOX DOPPIE CON MANICO ANATOMICO

Stainless steel double-ended Explorers with anatomic handle



n. 17/23
TD5025



n. 12/23
TD5026



n. 23/16
TD5027



n. 17/16
TD5028

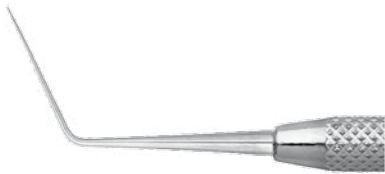

n. 12/16
TD5029



n. 17/6
TD5030



n. 23/6
TD5031



SONDE INOX MILLIMETRICHE PARODONTALI CON MANICO ANATOMICO

Stainless steel periodontal pocket probes with anatomic handle

LASER SYSTEM



Williams
TD5101



Merrit A
TD5102



Merrit B
TD5103



Goldman Fox
TD5104



University of
Michigan
TD5105



n. 26G
TD5106



n. 26G/A
TD5107

SONDE INOX MILLIMETRICHE PARODONTALI CON MANICO ANATOMICO LASER SYSTEM

Stainless steel periodontal pocket probes with anatomic handle laser system

LASER SYSTEM



TD5107ACP15
n° 26G/A CP15
Laser system



TD5108ACP15
CP15
Laser system



TD5108
CP12
Laser system



TD5109
CP11
Laser system



TD5110
CP12
Laser system



TD5110C
CPC
Laser system



TD5110S
CP12S
Laser system

SONDE INOX MILLIMETRICHE PARODONTALI DOPPIE CON MANICO ANATOMICO

Stainless steel periodontal pocket probes with anatomic handle

LASER SYSTEM



Goldman Fox
Williams
TD5111



Goldman Fox
Merrit B
TD5112



Goldman Fox
University of
Michigan
TD5113



COMBINAZIONE SONDE/SONDE MILLIMETRICHE CON MANICO ANATOMICO

Stainless steel combination explorer-probes with anatomic handle

LASER SYSTEM



Goldman Fox
n. 23
TD5139



University
of Michigan
n. 23
TD5140



Williams
n. 23
TD5141



Goldman Fox
n. 17
TD5142



University
of Michigan
n. 17
TD5143



Williams
n. 17
TD5144



Goldman Fox
n. 16
TD5145



University
of Michigan
n. 16
TD5146



Williams
n. 16
TD5147



STRUMENTO INOX PER TRATTAMENTI CANALARI CON MANICO ANATOMICO

Stainless steel endodontic instruments with anatomic handle

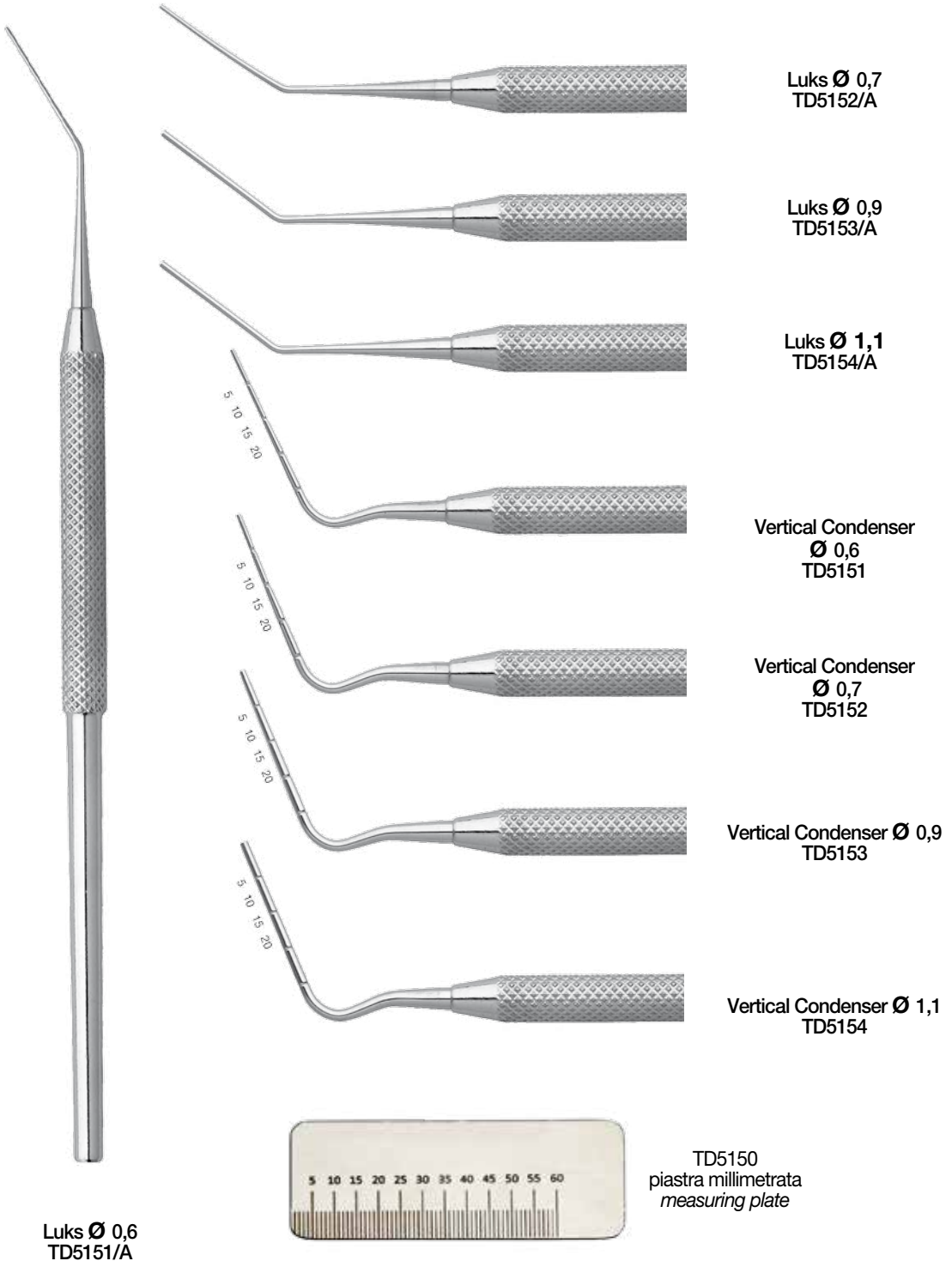

**STRUMENTO INOX PER TRATTAMENTI CANALARI
CON MANICO ANATOMICO**

Stainless steel endodontic instruments with anatomic handle

- 

Spreader
TD5131
- 

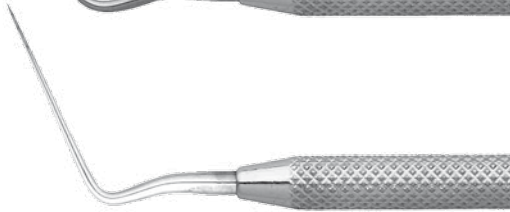
Spreader
TD5132
- 

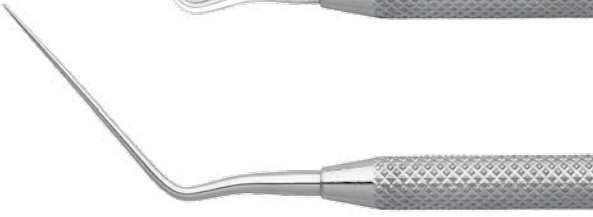
Spreader
TD5133
- 

Spreader
TD5134
- 

Spreader
TD5135
- 

Spreader
TD5136
- 

Spreader
TD5137

SPATOLE HEIDEMANN INOX CON MANICO ANATOMICO

Stainless steel heidemann separating spatulas with anatomic handle



n. 1
TD5171



n. 2
TD5172



n. 3
TD5173



TD5171/1
spatola



SPATOLE PER CEMENTI INOX
Stainless steel spatula for cements



Fig. 00
 Punta Doppia
 TD17005



Fig. 0 - Punta Doppia
 TD17004



Fig. 1 - Punta Doppia
 TD17003



Fig. 2 - Punta Doppia
 TD17002



Fig. 3 - Punta Doppia
 TD17001

OTTURATORI INOX CON MANICO ANATOMICO

Stainless steel filling instruments with anatomic handle



Westcott n. 1
TD5069

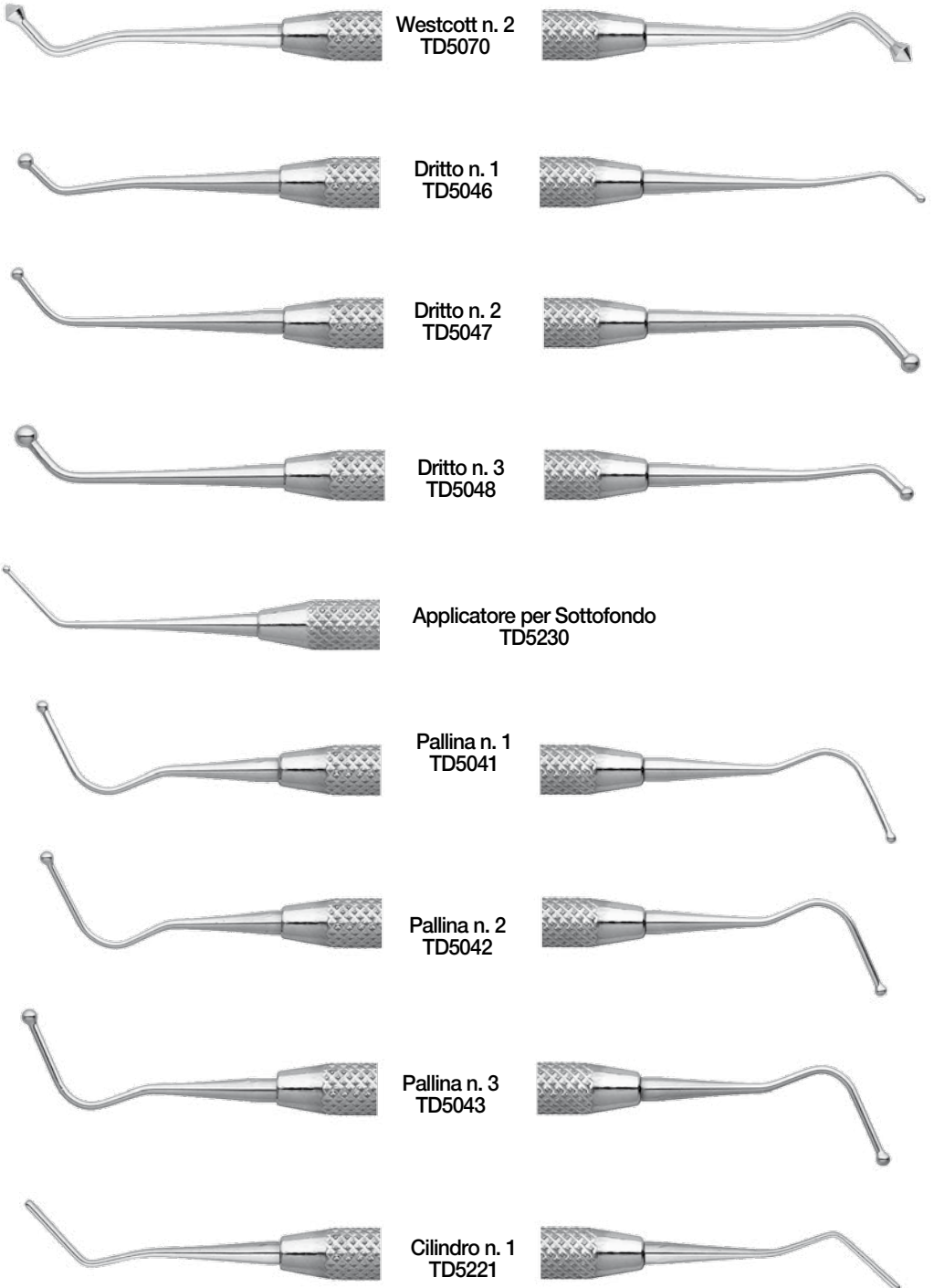

Westcott n. 2
TD5070

Dritto n. 1
TD5046

Dritto n. 2
TD5047

Dritto n. 3
TD5048

Applicatore per Sottofondo
TD5230

Pallina n. 1
TD5041

Pallina n. 2
TD5042

Pallina n. 3
TD5043

Cilindro n. 1
TD5221

OTTURATORI INOX CON MANICO ANATOMICO

Stainless steel filling instruments with anatomic handle



Cilindro n. 2
TD5222



Cilindro n. 3
TD5223



n. 1
TD5224



n. 2
TD5225



n. 3
TD5226



n. 4
TD5227



n. 5
TD5228



Cono Lungo
TD5231



Piano n. 1
TD5236



OTTURATORI INOX CON MANICO ANATOMICO

Stainless steel filling instruments with anatomic handle

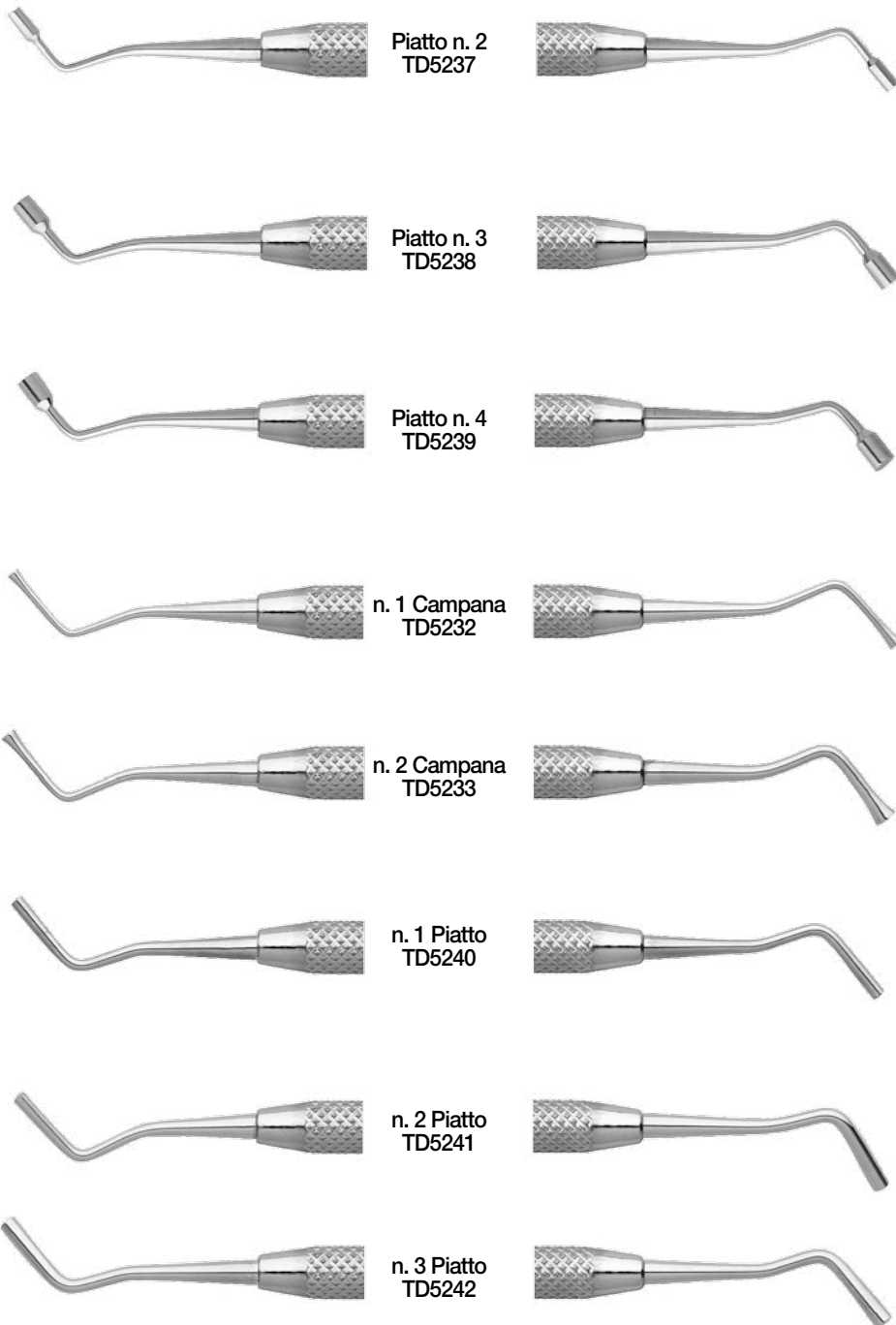

STRUMENTI INOX PER OTTURAZIONI PLASTICHE CON MANICO ANATOMICO

Stainless steel plastic filling instruments with anatomic handle



Spatola Piana
otturatore n. 1
TD5075



Spatola Piana
otturatore n. 2
TD5076



Spatola Piana
otturatore n. 3
TD5077



Spatola a coltello
otturatore n. 1
TD5078



Spatola a coltello
otturatore n. 2
TD5079



Spatola a coltello
otturatore n. 3
TD5080



Spatola piccola
piana
otturatore n. 1
TD5081



Spatola piccola
piana
otturatore n. 2
TD5082



Spatola piccola
piana
otturatore n. 3
TD5083



STRUMENTI INOX PER OTTURAZIONI PLASTICHE CON MANICO ANATOMICO

Stainless steel plastic filling instruments with anatomic handle

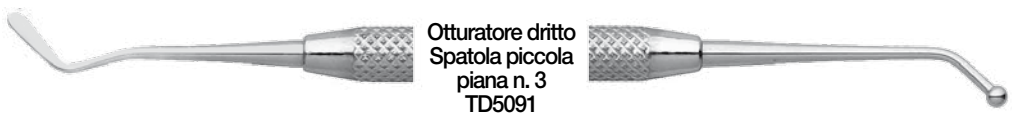
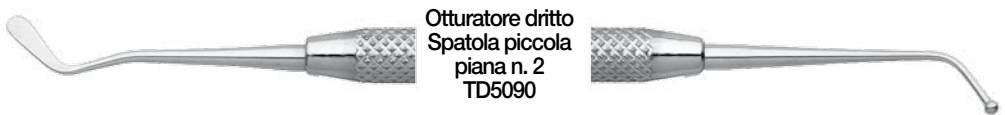
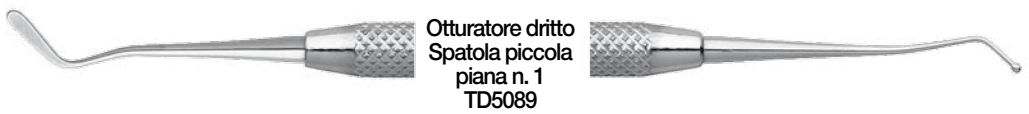
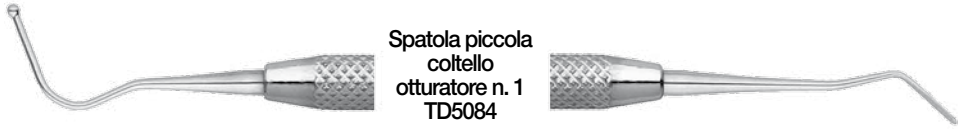

STRUMENTI INOX PER OTTURAZIONI PLASTICHE CON MANICO ANATOMICO

Stainless steel plastic filling instruments with anatomic handle



Otturatore dritto
Spatola piccola
coltello n. 1
TD5092

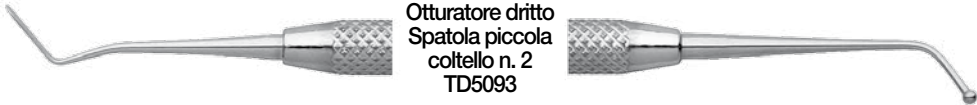

Otturatore dritto
Spatola piccola
coltello n. 2
TD5093

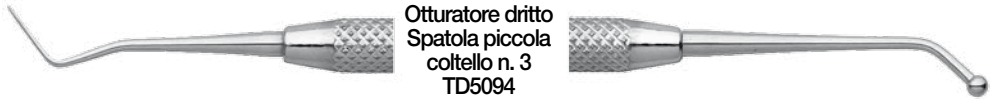

Otturatore dritto
Spatola piccola
coltello n. 3
TD5094

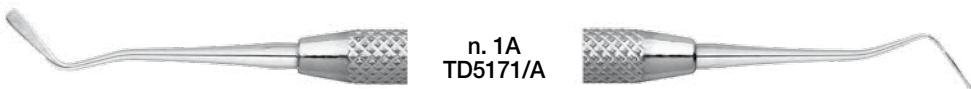

n. 1A
TD5171/A

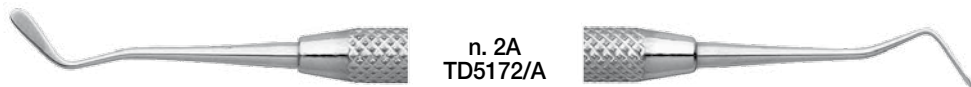

n. 2A
TD5172/A

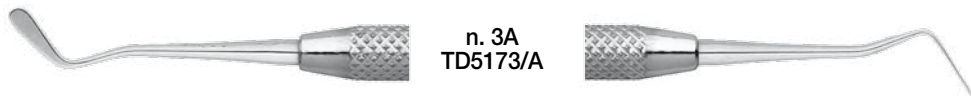

n. 3A
TD5173/A



TD5174

ESCAVATORI INOX CON MANICO ANATOMICO*Stainless steel excavator with anatomic handle*

n. 0
TD5190



n. 1
TD5191



n. 2
TD5192



n. 3
TD5193



n. 4
TD5194



CURETTES INOX CON MANICO ANATOMICO

Stainless steel currettes with anatomic handle



n. 1/2
TD5260



n. 3/4
TD5261



n. 5/6
TD5262



n. 7/8
TD5263



n. 9/10
TD5264



n. 11/12
TD5265



n. 13/14
TD5266



CUCCHIAI ALVEOLARI HEMINGWAY INOX CON MANICO ANATOMICO

Stainless steel alveolar spoon with anatomic handle



Cucchiaio alveolare
Hemingway N°1
TD5201



Cucchiaio
alveolare
Hemingway
N°2
TD5202



Cucchiaio
alveolare
Hemingway
N°3
TD5203



Cucchiaio
alveolare
Hemingway
N°4
TD5204





STRUMENTI MANICO VUOTO

ACCIAIO INOX

INSTRUMENTS WITH EMPTY HANDLE

STAINLESS STEEL

SONDE INOX CON MANICO VUOTO

Stainless steel Explorers with empty handle



n. 2
TD15002



n. 5
TD15005

n. 6
TD15006

n. 8
TD15008

n. 8A
TD15008/A

n. 9
TD15009

n. 10
TD15010

n. 11
TD15011

n. 12
TD15012

n. 16
TD15016

n. 17
TD15017

n. 23
TD15023

SONDE INOX DOPPIE CON MANICO VUOTO

Stainless steel double-ended Explorers with empty handle



n. 17/23
TD15025



n. 12/23
TD15026



n. 23/16
TD15027



n. 17/16
TD15028



n. 12/16
TD15029



n. 17/6
TD15030



n. 26/3
TD15031



**SONDE INOX MILLIMETRICHE PARODONTALI
CON MANICO ANATOMICO**
Stainless steel periodontal pocket probes with empty handle

LASER SYSTEM



**Williams
TD15101**



**Merrit A
TD15102**



**Merrit B
TD15103**



**Goldman Fox
TD15104**



**University of
Michigan
TD15105**



**n. 26G
TD15106**



**n. 26G/A
TD15107**

**SONDE INOX MILLIMETRICHE PARODONTALI
CON MANICO VUOTO LASER SYSTEM**

Stainless steel periodontal pocket probes with empty laser system

LASER SYSTEM

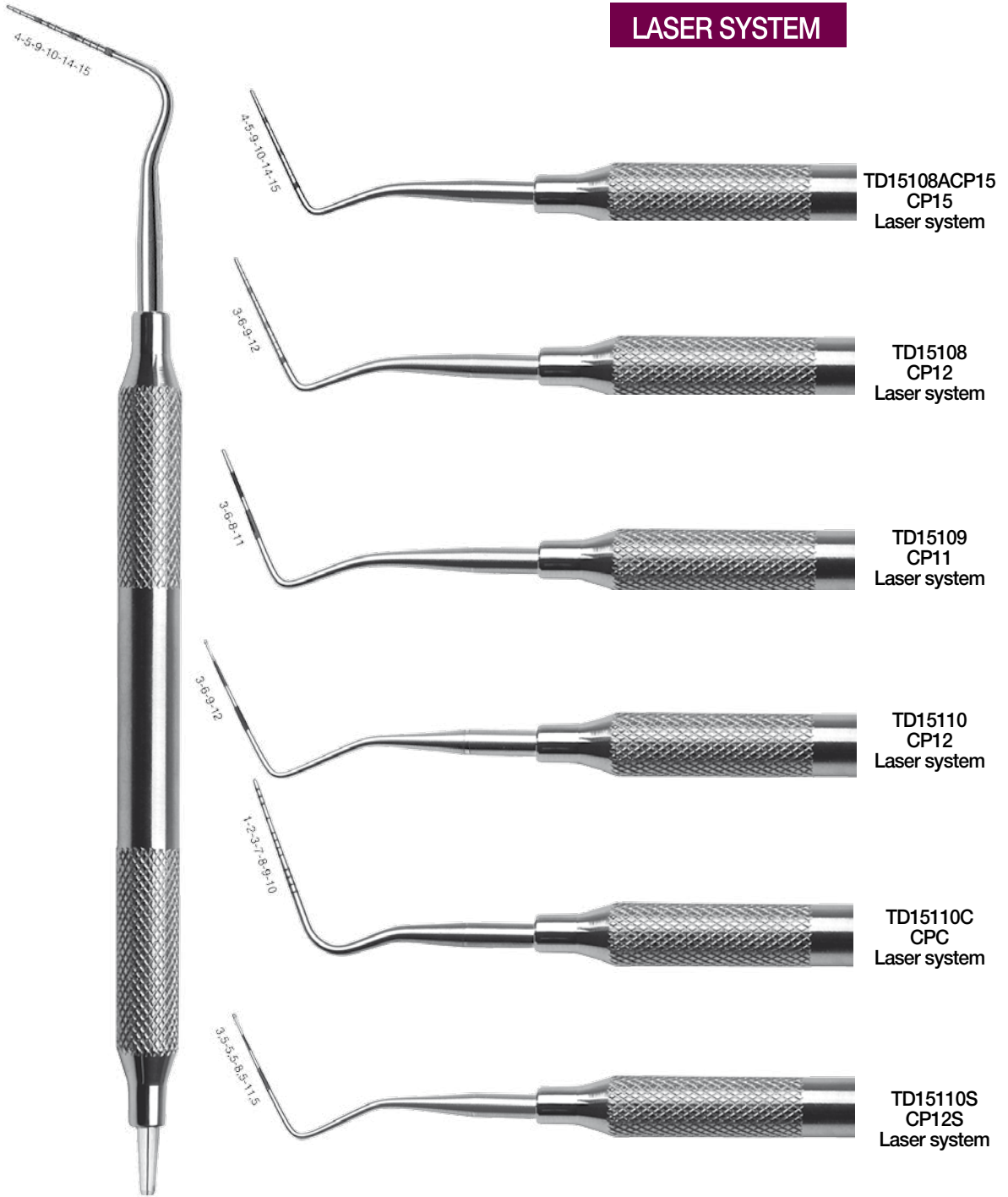

TD15107ACP15
n° 26G/A CP15
Laser system

TD15108ACP15
CP15
Laser system

TD15108
CP12
Laser system

TD15109
CP11
Laser system

TD15110
CP12
Laser system

TD15110C
CPC
Laser system

TD15110S
CP12S
Laser system

SONDE INOX MILLIMETRICHE PARODONTALI DOPPIE CON MANICO VUOTO

Stainless steel periodontal pocket probes with empty handle

LASER SYSTEM



Goldman Fox
Williams
TD15111

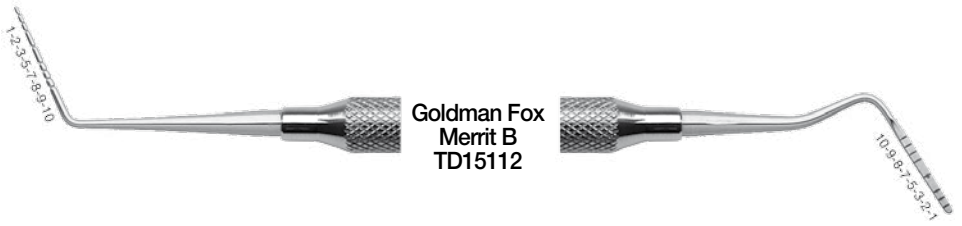

Goldman Fox
Merrit B
TD15112



Goldman Fox
University of
Michigan
TD15113

COMBINAZIONE SONDE/SONDE MILLIMETRICHE CON MANICO VUOTO

Stainless steel combination explorer-probes with empty handle

LASER SYSTEM



Goldman Fox
n. 23
TD15139



University
of Michigan
n. 23
TD15140



Williams
n. 23
TD15141



Goldman Fox
n. 17
TD15142



University
of Michigan
n. 17
TD15143



Williams
n. 17
TD15144



Goldman Fox
n. 16
TD15145



University
of Michigan
n. 16
TD15146



Williams
n. 16
TD15147



STRUMENTO INOX PER TRATTAMENTI CANALARI CON MANICO VUOTO

Stainless steel endodontic instruments with empty handle

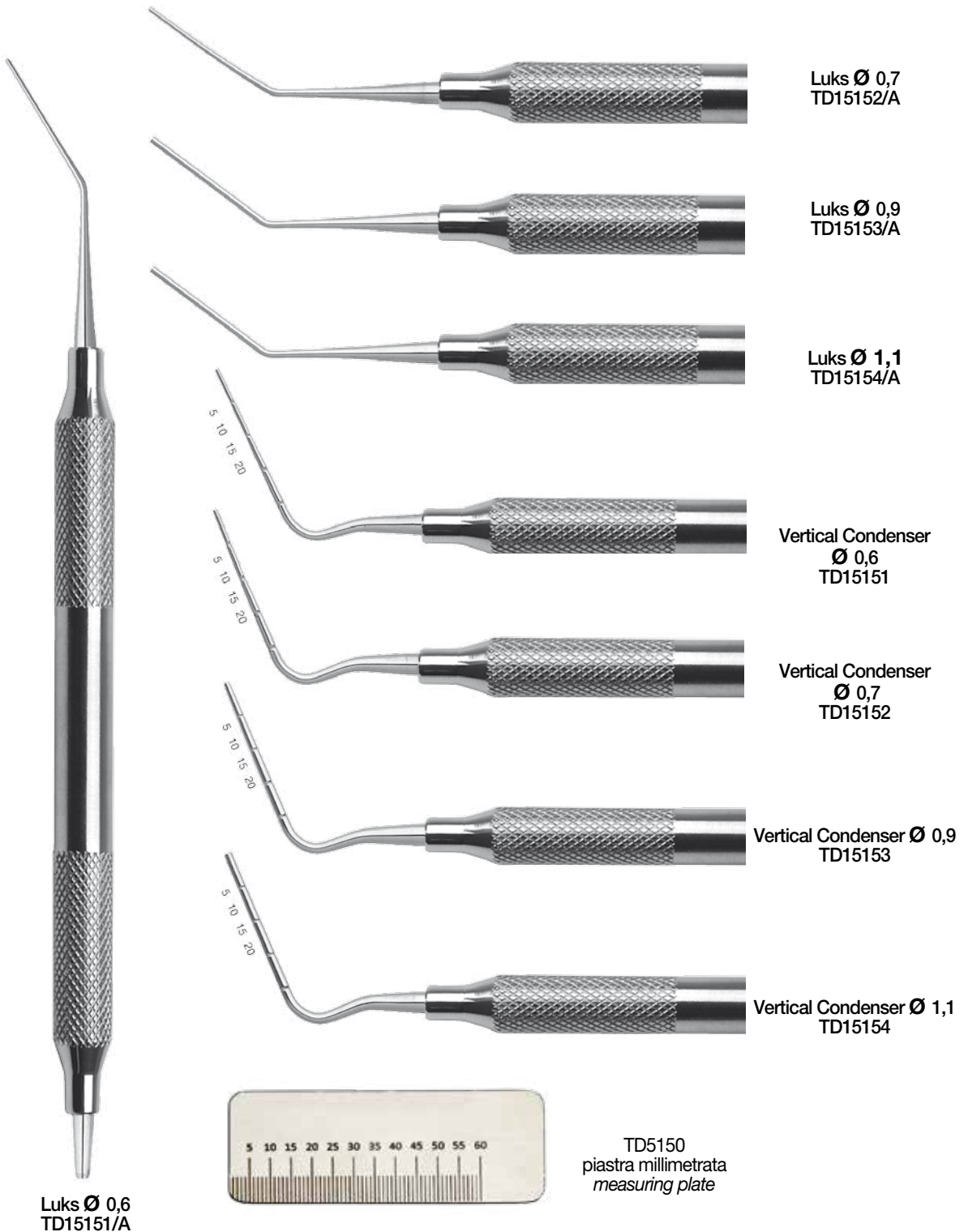

STRUMENTO INOX PER TRATTAMENTI CANALARI CON MANICO VUOTO

Stainless steel endodontic instruments with empty handle

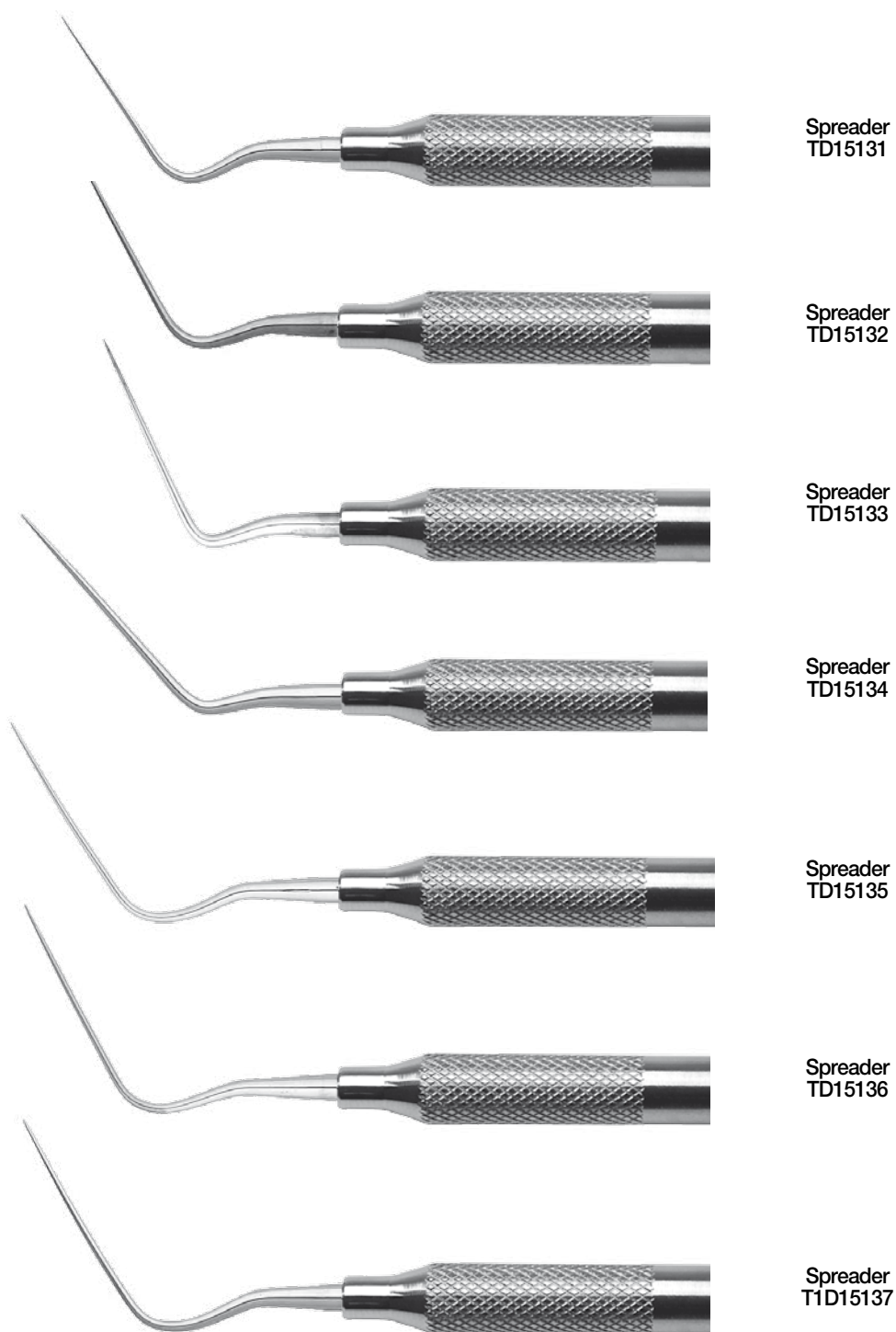

SPATOLE HEIDEMANN INOX CON MANICO VUOTO*Stainless steel heidemann separating spatulas with empty handle*

n. 1
TD15171



n. 2
TD15172



n. 3
TD15173



OTTURATORI INOX CON MANICO VUOTO

Stainless steel filling instruments with empty handle



Westcott n. 1
TD15069

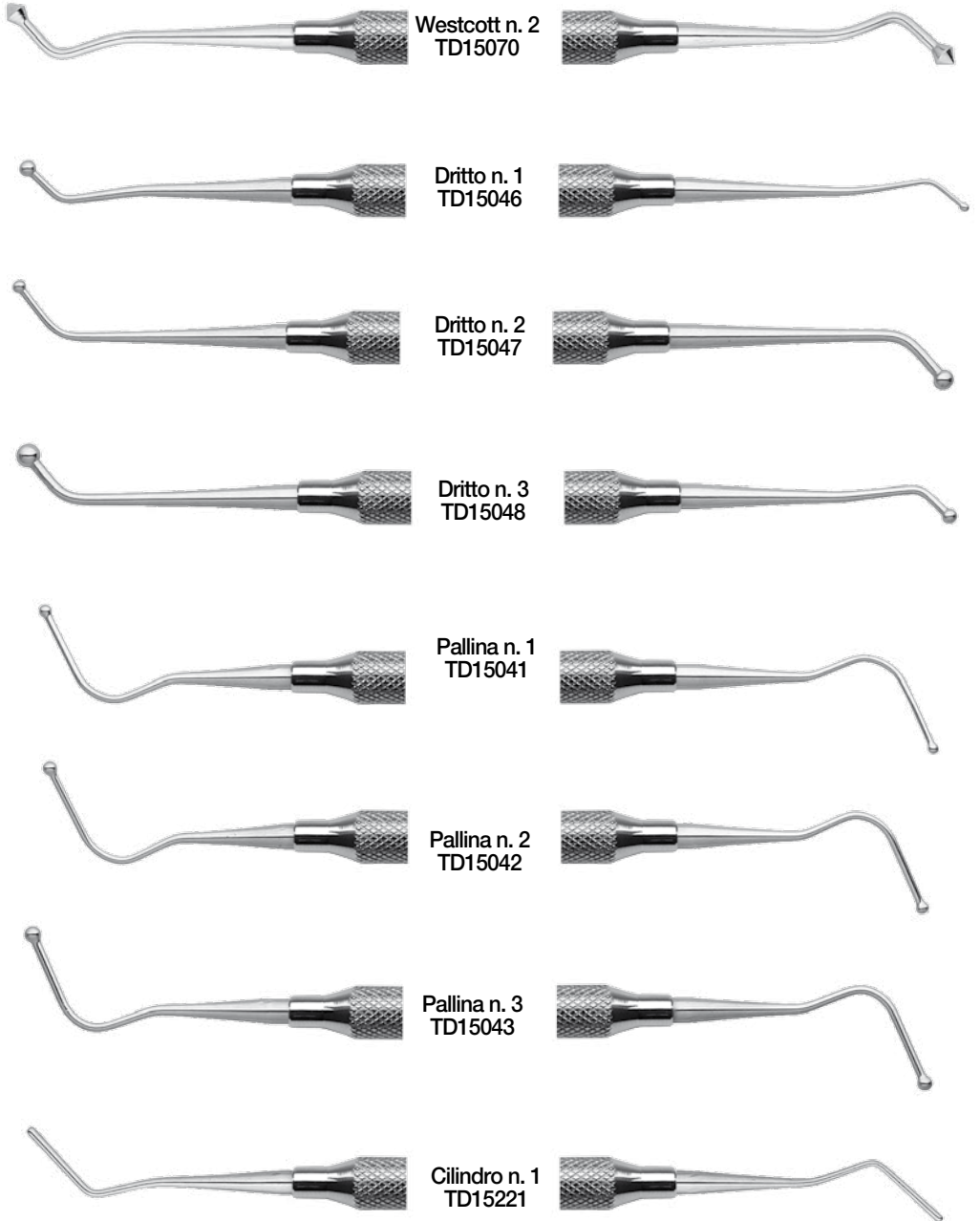

OTTURATORI INOX CON MANICO VUOTO

Stainless steel filling instruments with empty handle

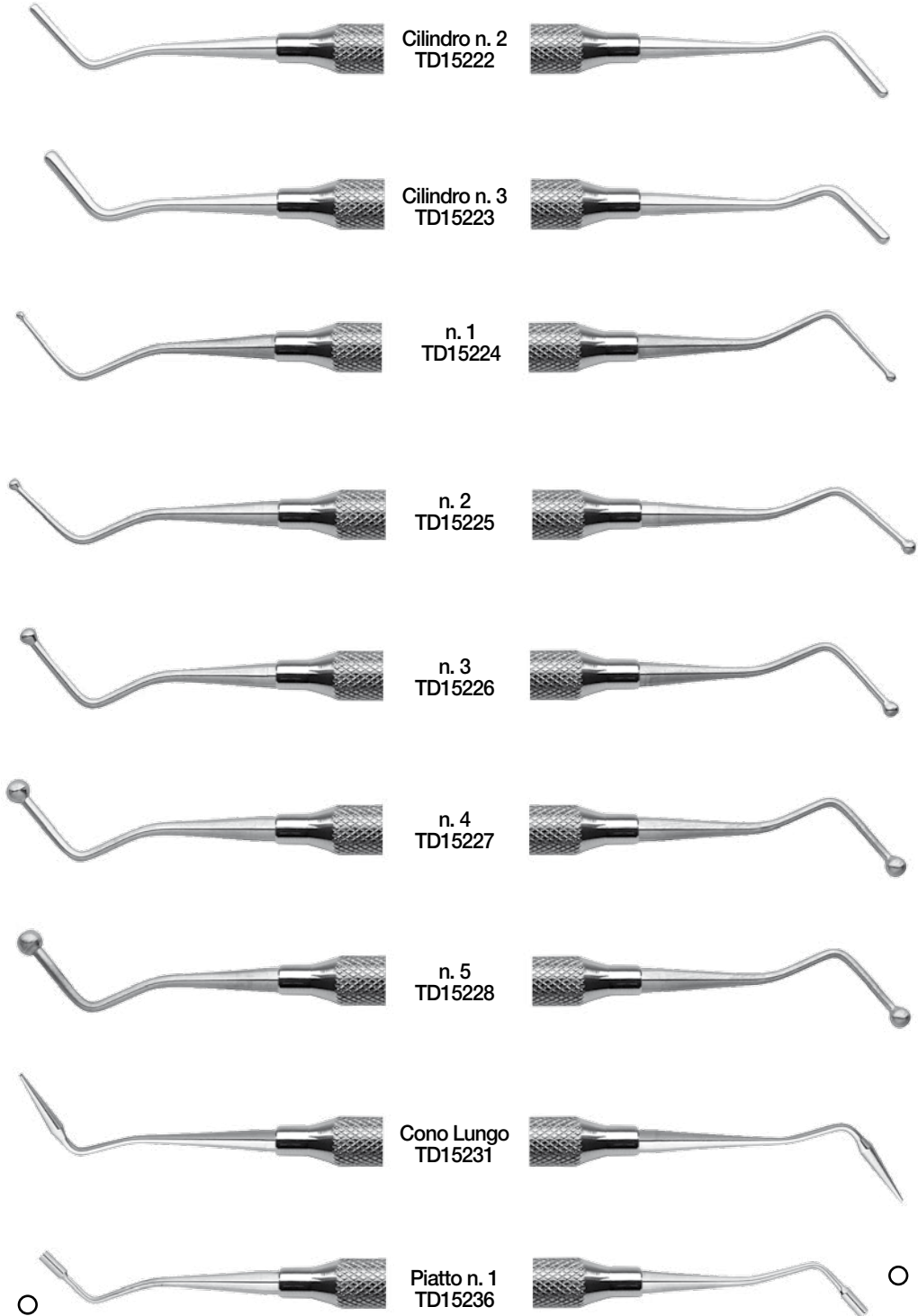

OTTURATORI INOX CON MANICO VUOTO

Stainless steel filling instruments with empty handle



Piatto n. 2
TD15237



Piatto n. 3
TD15238



Piatto n. 4
TD15239



n. 1 Campana
TD15232



n. 2 Campana
TD15233



n. 1 Piatto
TD15240



n. 2 Piatto
TD15241



n. 3 Piatto
TD15242

STRUMENTI INOX PER OTTURAZIONI PLASTICHE CON MANICO VUOTO

Stainless steel plastic filling instruments with empty handle

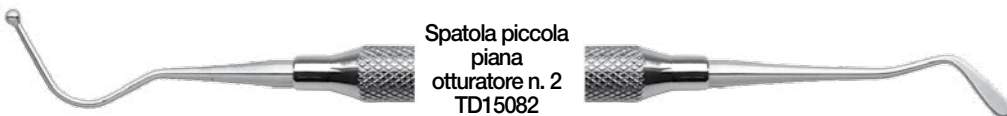

Spatola Piana
otturatore n. 1
TD15075

STRUMENTI INOX PER OTTURAZIONI PLASTICHE CON MANICO VUOTO

Stainless steel plastic filling instruments with empty handle



Spatola piccola
coltello
otturatore n. 1
TD15084



Spatola piccola
coltello
otturatore n. 2
TD15085



Spatola piccola
coltello
otturatore n. 3
TD15086



Applicatore
sottofondo
Spatola piccola
coltello n. 1
TD15088



Applicatore
sottofondo
Spatola piccola
piana n. 1
TD15087

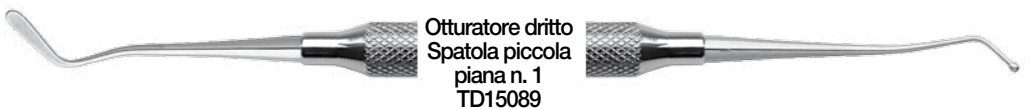

Otturatore dritto
Spatola piccola
piana n. 1
TD15089

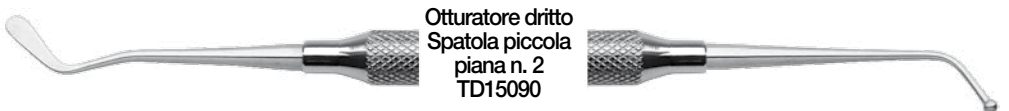

Otturatore dritto
Spatola piccola
piana n. 2
TD15090

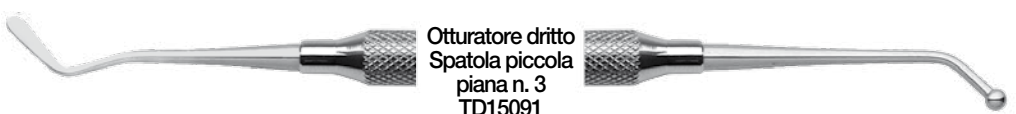

Otturatore dritto
Spatola piccola
piana n. 3
TD15091

STRUMENTI INOX PER OTTURAZIONI PLASTICHE CON MANICO VUOTO

Stainless steel plastic filling instruments with empty handle

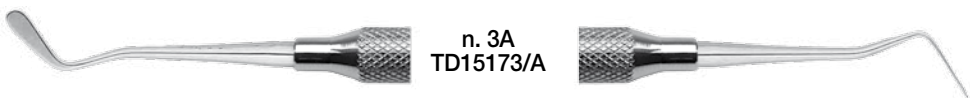
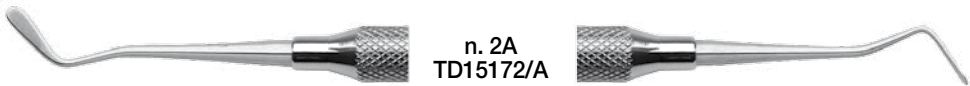
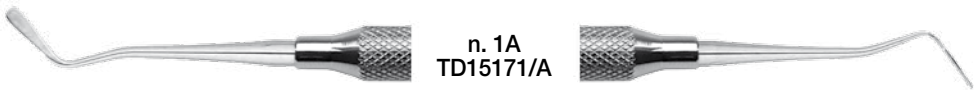
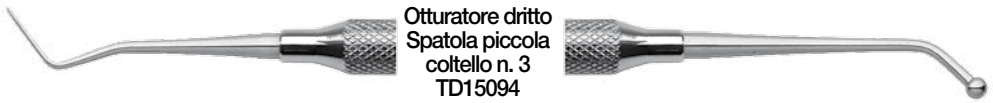
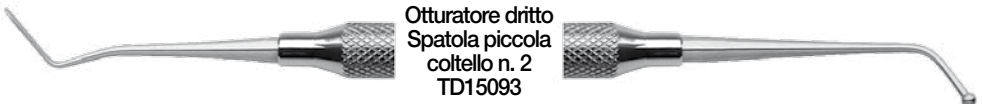
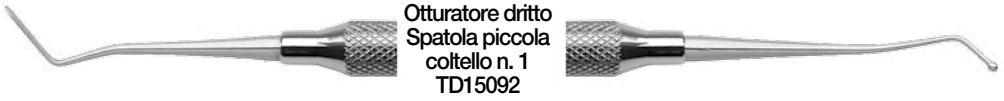

ESCAVATORI INOX CON MANICO VUOTO

Stainless steel excavator with empty handle



n. 0
TD15190



n. 1
TD15191



n. 2
TD15192



n. 3
TD15193



n. 4
TD15194





STRUMENTI MANICO COLORATO

ACCIAIO INOX

INSTRUMENTS WITH COLOURED HANDLE

STAINLESS STEEL

**SONDE CON MANICO COLORATO
ULTRALEGGERO**
Explorers with coloured handle



n. 2
TD8002



n. 5
TD8005A



n. 6
TD8006



n. 8
TD8008



n. 8A
TD8008A



n. 9
TD8009

**SONDE CON MANICO COLORATO
ULTRALEGGERO**

Explorers with coloured handle



n. 10
TD8010



n. 11
TD8011



n. 12
TD8012



n. 16
TD8016



n. 17
TD8017



n. 23
TD8023

AUTOCLAVABLE
135°

**SONDE DOPPIE CON MANICO ULTRALEGGERO
IN SILICONE COLORATO**
Explorers with coloured handle



n. 23/16
TD8027

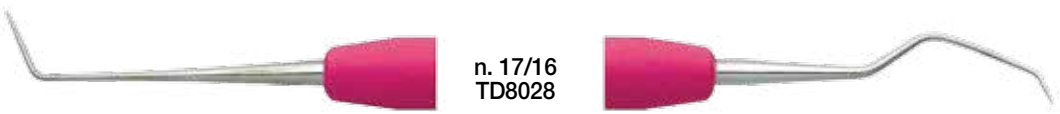

n. 17/16
TD8028

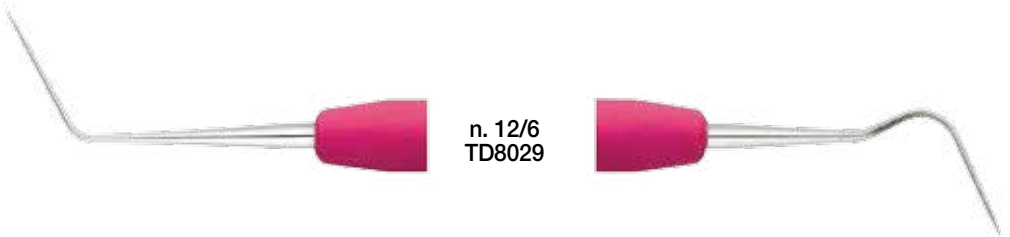

n. 12/6
TD8029

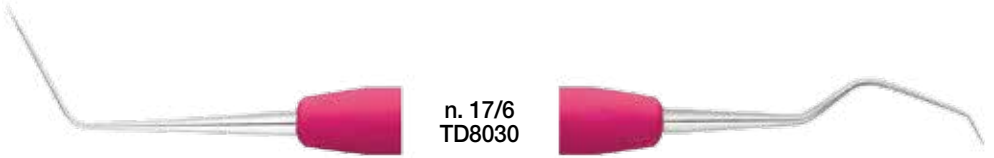

n. 17/6
TD8030



n. 26/3
TD8031

**SONDE MILLIMETRICHE PARODONTALI
CON MANICO COLORATO ULTRALEGGERO**
Periodontal pocket probes with coloured handle



**Williams
TD8101**



**Merrit A
TD8102**



**Merrit B
TD8103**



**Goldman Fox
TD8104**



**University of Michigan
TD8105**



**n. 26G
TD8106**



**n. 26G/A
TD8107**

AUTOCLAVABLE
135°

**SONDE MILLIMETRICHE PARODONTALI DOPPIE
CON MANICO COLORATO ULTRALEGGERO**

Periodontal pocket probes with coloured handle

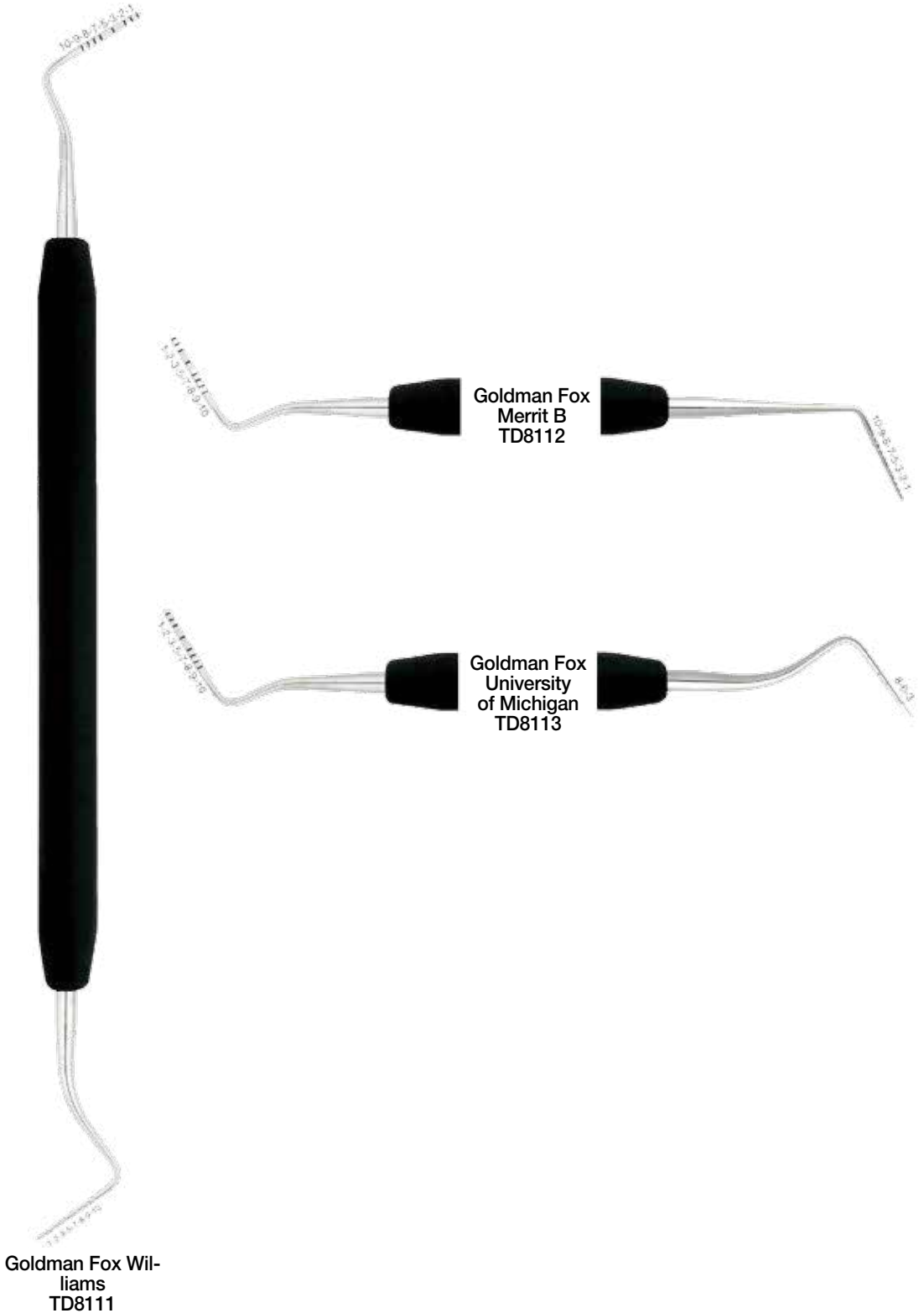

**COMBINAZIONE SONDE /SONDE MILLIMETRICHE
CON MANICO COLORATO ULTRALEGGERO**

Combination explorer -probes with coloured handle

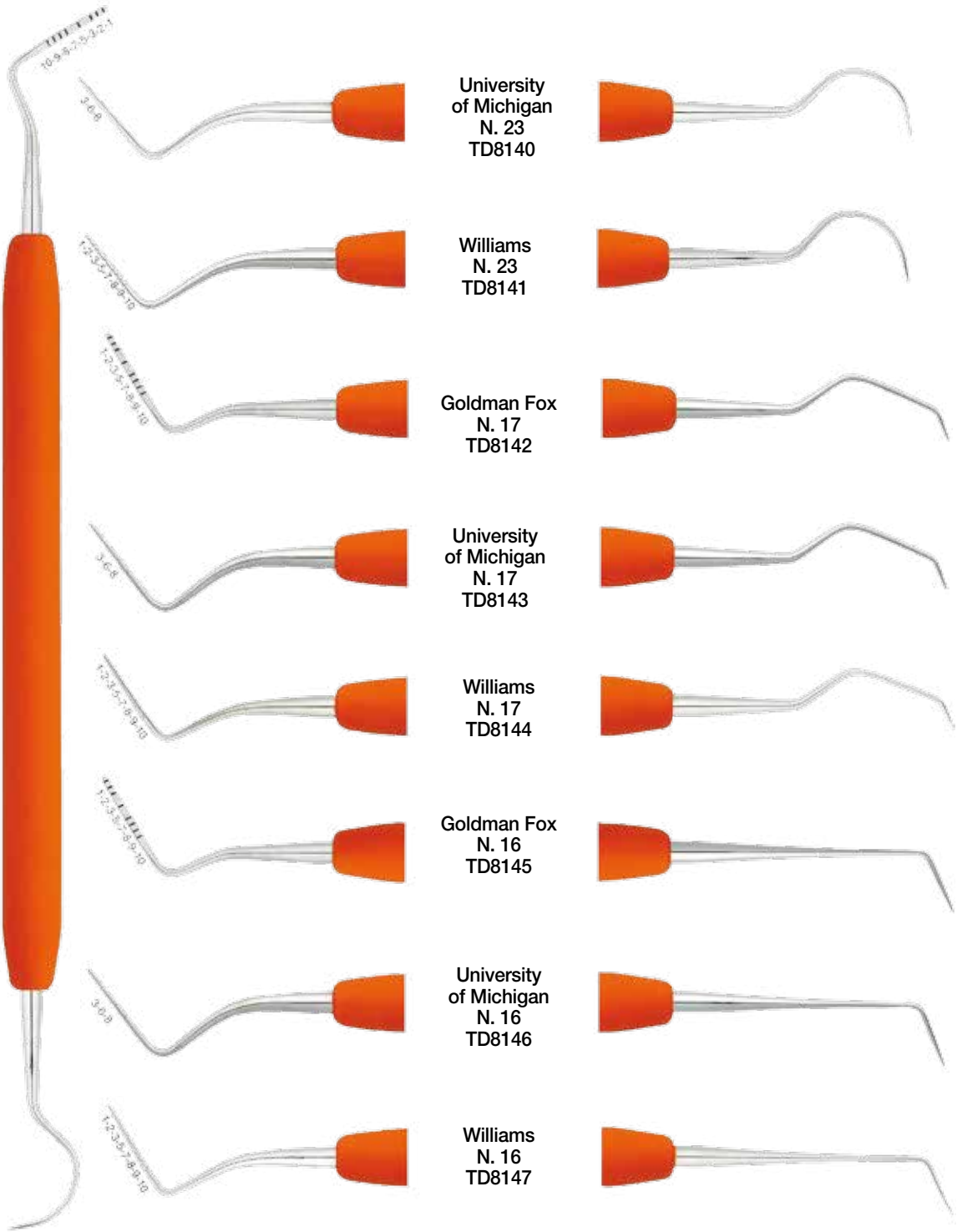

Goldman Fox N. 23
TD8139

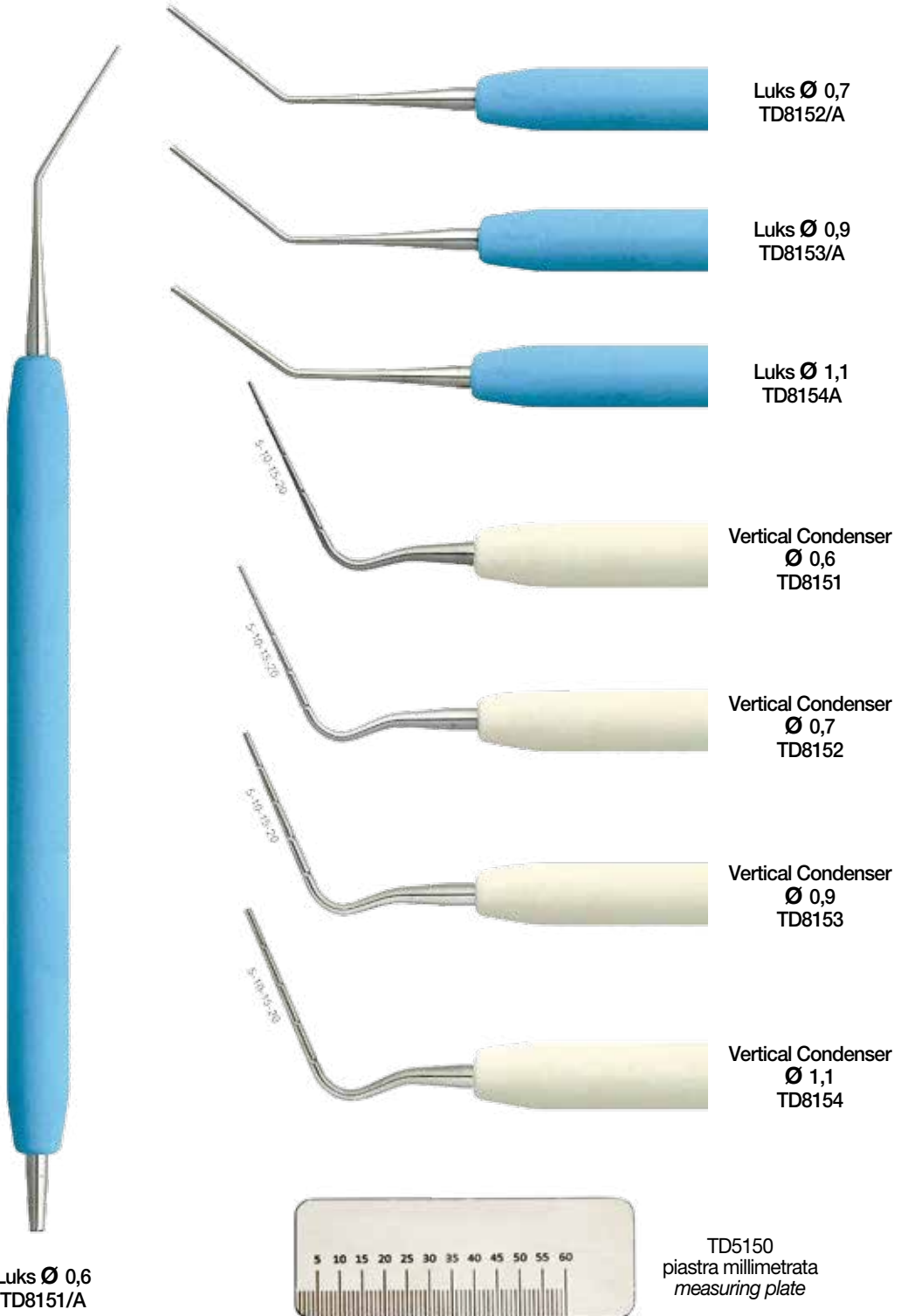
**STRUMENTI PER TRATTAMENTI CANALARI
 CON MANICO COLORATO ULTRALEGGERO**
Endodontic instruments with coloured handle

**STRUMENTI PER TRATTAMENTI CANALARI
CON MANICO COLORATO ULTRALEGGERO**

Endodontic instruments with coloured handle

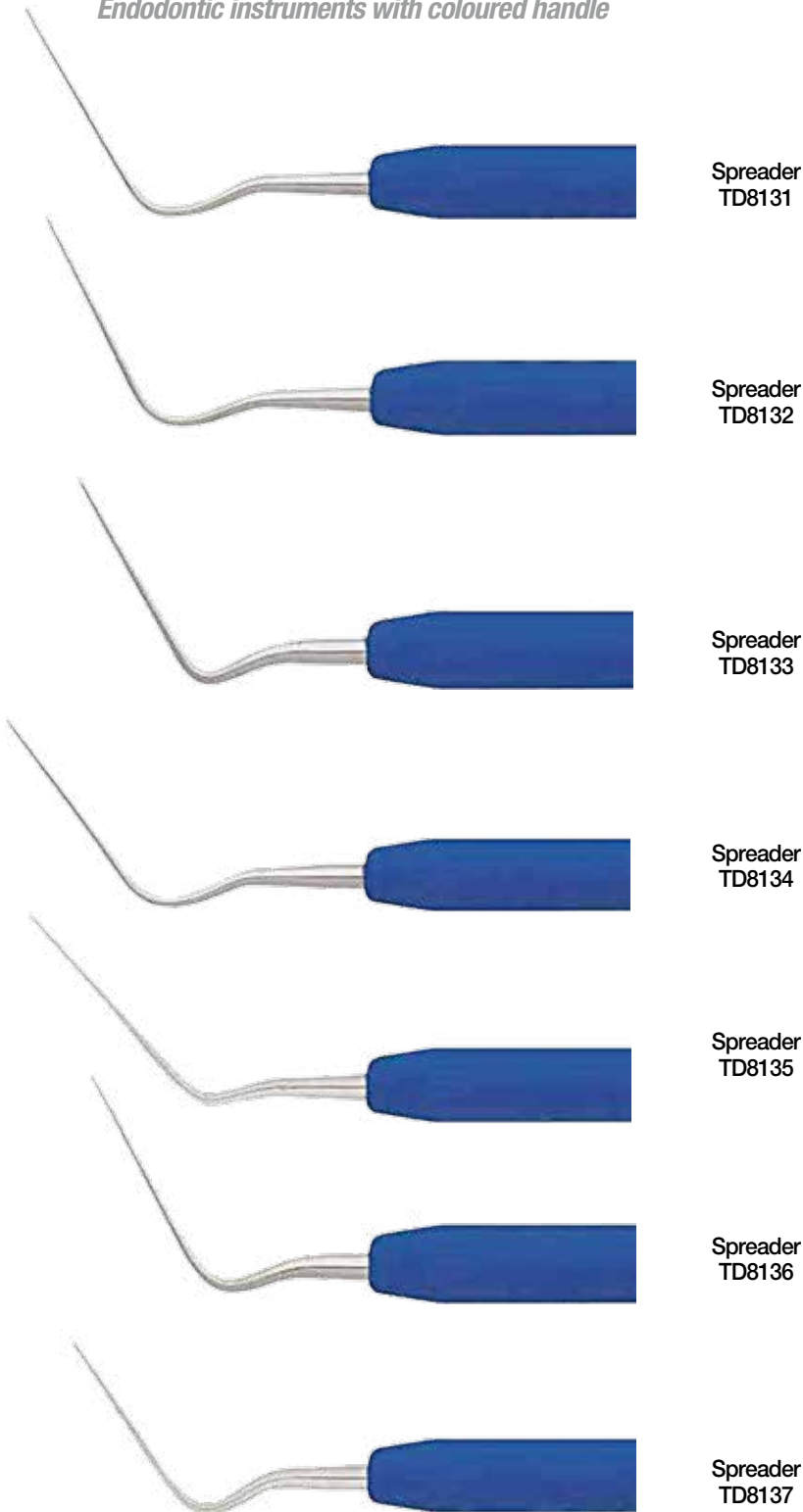

AUTOCLAVABLE
135°**SPATOLE HEIDEMANN CON MANICO COLORATO
ULTRALEGGERO***Heidemann separating spatulas with coloured handle*n. 1
TD8171n. 2
TD8172n. 3
TD8173

**OTTURATORI CON MANICO COLORATO
ULTRALEGGERO**

Filling instruments with coloured handle



Westcott n. 1
TD8069

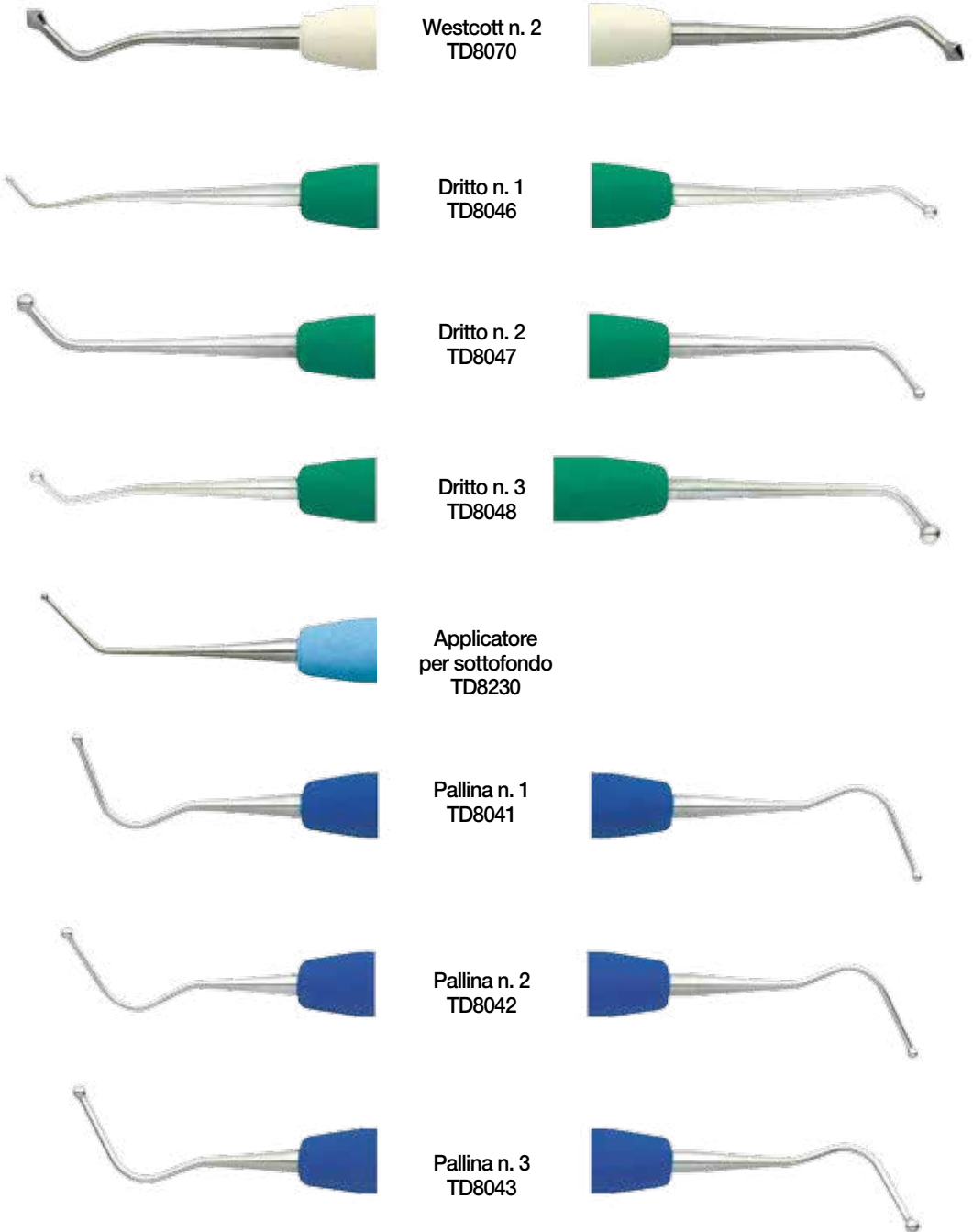

Westcott n. 2
TD8070

Dritto n. 1
TD8046

Dritto n. 2
TD8047

Dritto n. 3
TD8048

Applicatore
per sottofondo
TD8230

Pallina n. 1
TD8041

Pallina n. 2
TD8042

Pallina n. 3
TD8043

**OTTURATORI CON MANICO COLORATO
ULTRALEGGERO***Filling instruments with coloured handle***Cilindro n. 1**
TD8221**Cilindro n. 2**
TD8222**Cilindro n. 3**
TD8223

STRUMENTI PER OTTURAZIONI PLASTICHE CON MANICO COLORATO ULTRALEGGERO

Plastic filling instruments with coloured handle



Spatola Piana
 Otturatore n. 1
 TD8075



Spatola Piana
 Otturatore n. 2
 TD8076



Spatola Piana
 Otturatore n. 3
 TD8077



Spatola coltello
 Otturatore n. 1
 TD8078



Spatola coltello
 Otturatore n. 2
 TD8079



Spatola coltello
 Otturatore n. 3
 TD8080



Spatola piccola Piana
 Otturatore n. 1
 TD8081



Spatola piccola Piana
 Otturatore n. 2
 TD8082



STRUMENTI PER OTTURAZIONI PLASTICHE CON MANICO COLORATO ULTRALEGGERO

Plastic filling instruments with coloured handle

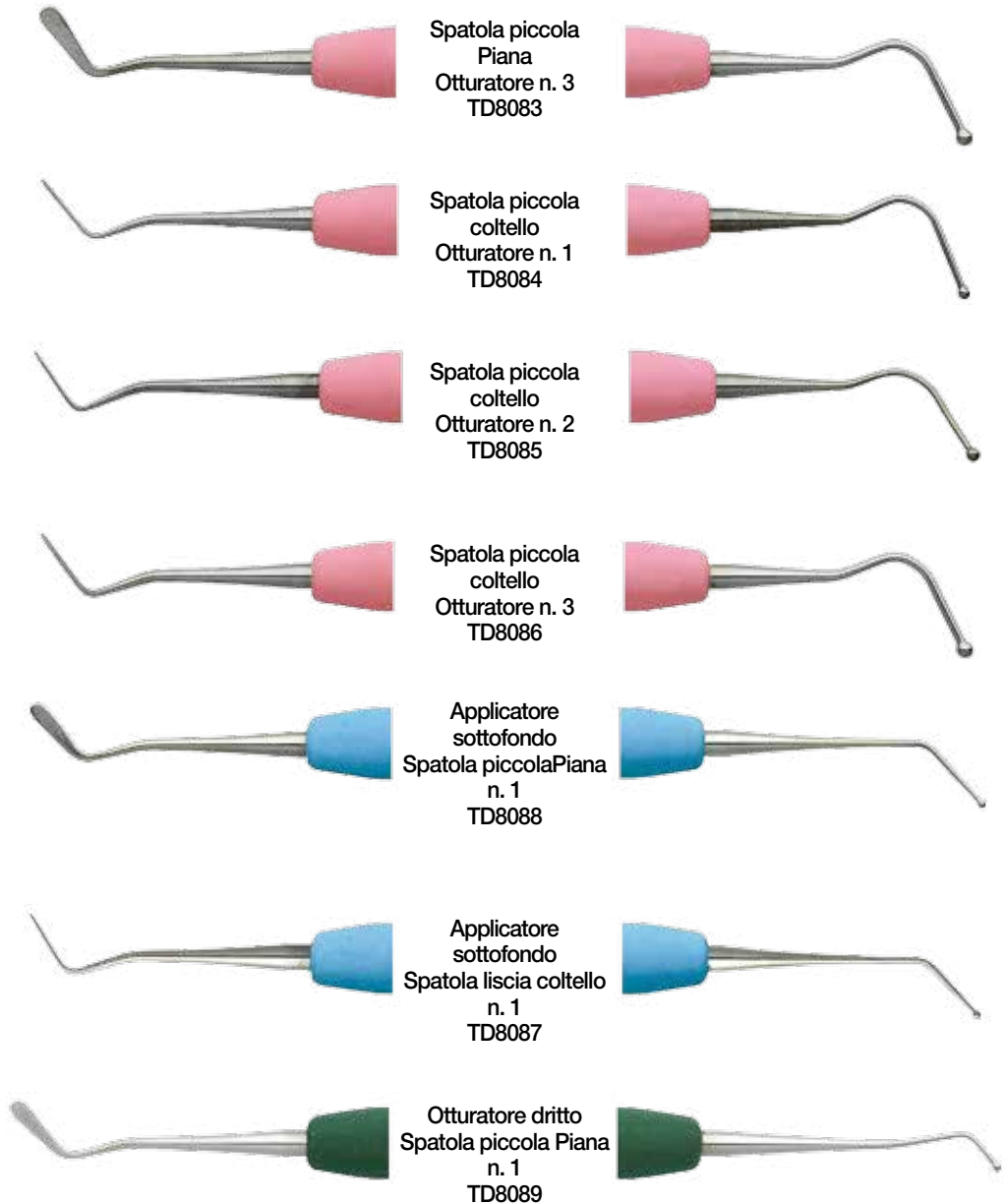

STRUMENTI PER OTTURAZIONI PLASTICHE CON MANICO COLORATO

Plastic filling instruments with coloured handle

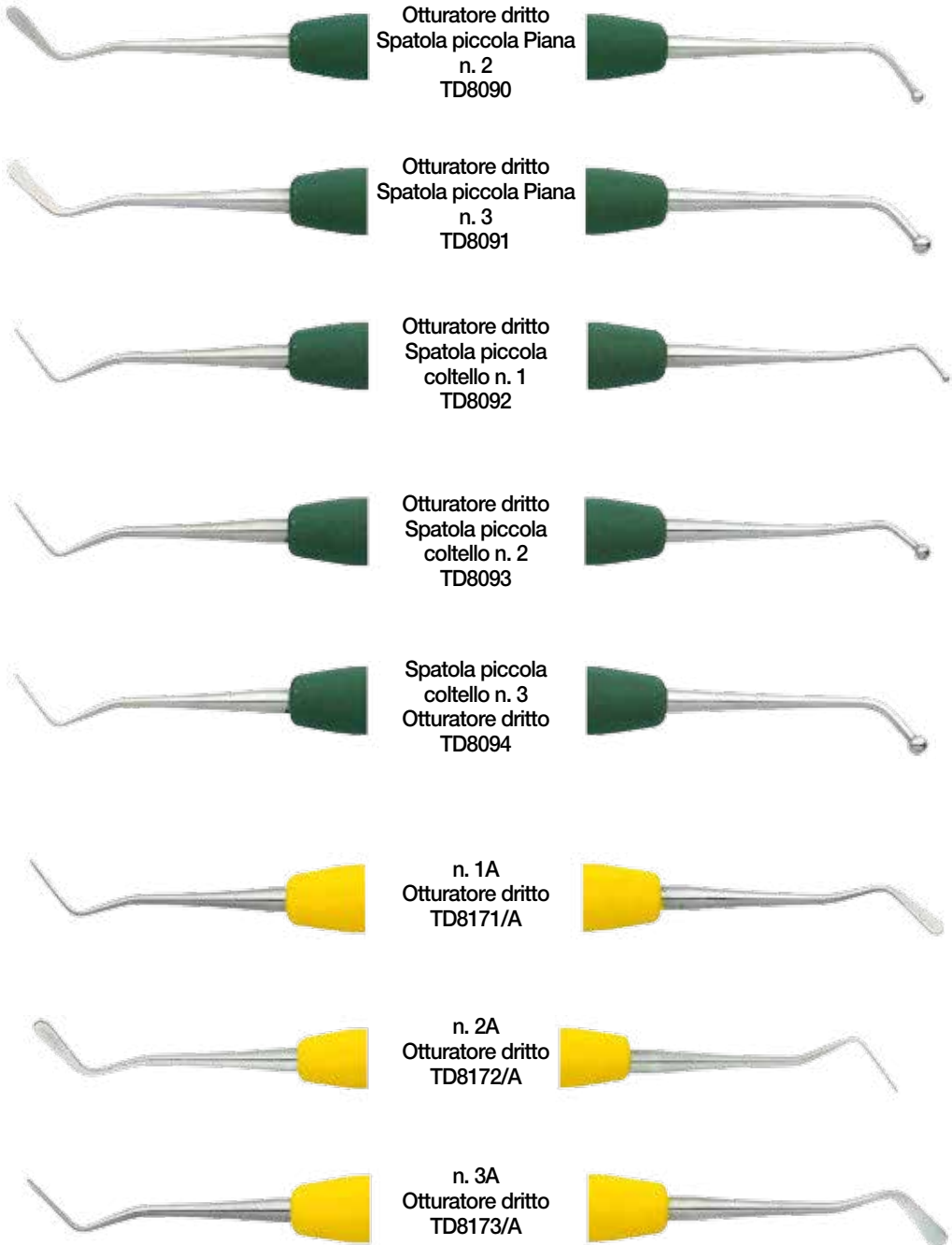

ESCAVATORI CON MANICO COLORATO

Excavators with coloured handle



n. 1
TD8191



n. 2
TD8192



n. 3
TD8193



n. 4
TD8194



n. 0
TD8190

CURETTES CON MANICO COLORATO
Curettes with coloured handle



n. 1/2
TD8260

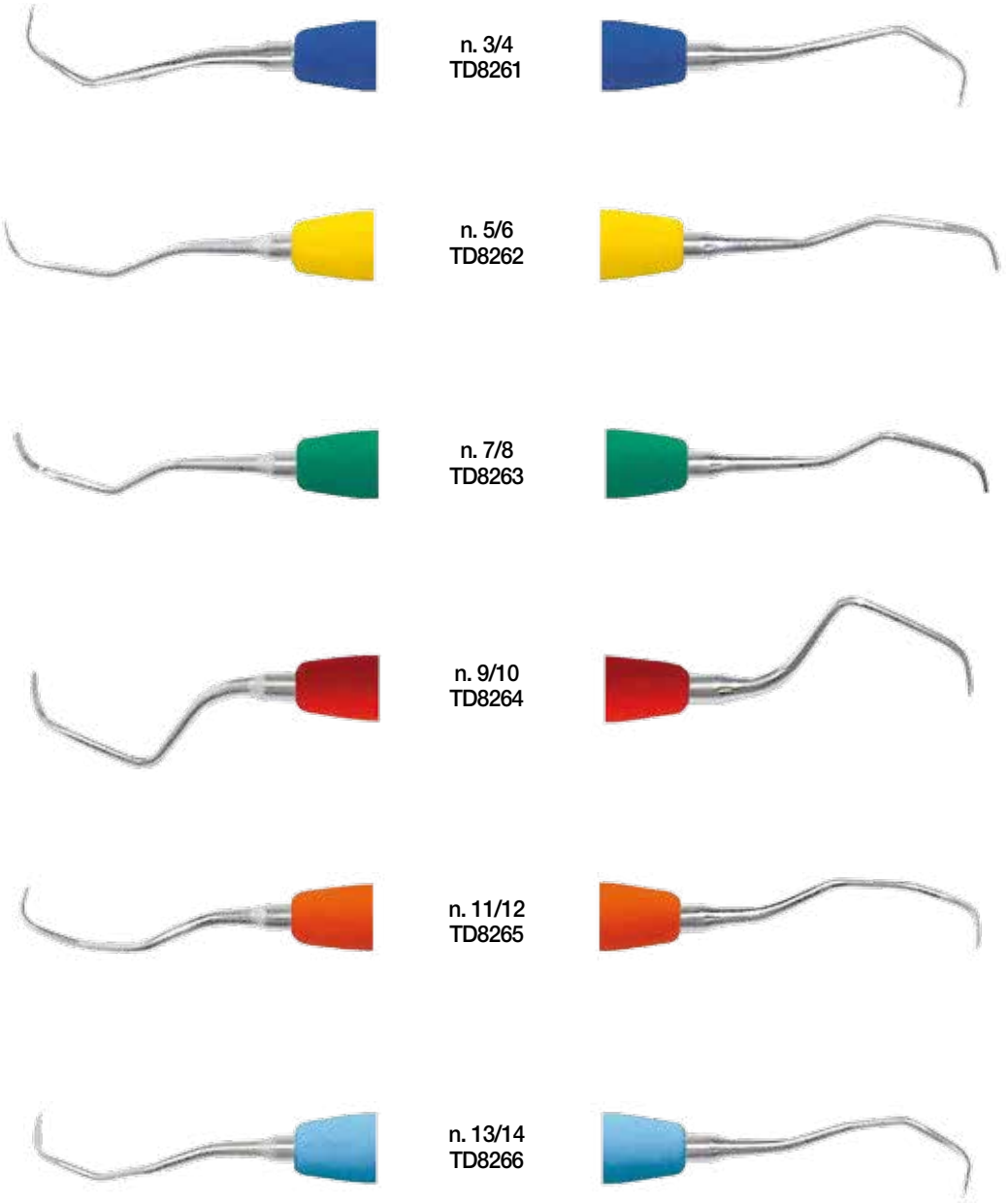



STRUMENTARIO CHIRURGICO
ACCIAIO INOX
SURGICAL INSTRUMENTS
STAINLESS STEEL

MANICI E SPECCHIETTI

Handles and mirrors



TD4900
n. 5 piano



TD4902
n. 6 piano



TD4901
n. 4 piano



TD4905
n° 4 Rodio



TD4906
n° 5 Rodio

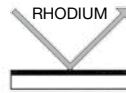

riflessione sul fondo
dello specchio

BOX 12 Pcs



TD5001 - Manico inox anatomico - *Anatomic handle*



TD5000 - Manico inox ottagonale - *Octagonal handle*



TD4999 - Manico inox rotondo liscio - *Smooth handle*

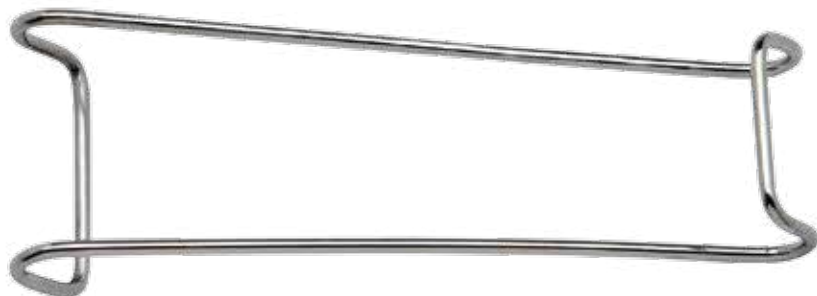

TD8000 - Manico colorato (autoclavabile max. 135°) - *Coloured handle (autoclavable max 135°)*

DIVARICATORI*Retractor*

Columbia cm 14
TD13302



Langenbeck cm 21
Divaricatore grande
TD13305



Langenbeck cm 21
Divaricatore piccolo
TD13306

PINZETTE PER MEDICAZIONE E SCOLLAPERIOSTEI

Dressing tweezers and periosteal elevator



Meriam cm 16
TD13001



College cm 15
TD13002



Scollaperiosteo
Freer
TD14001



Scollaperiosteo
Prichard
TD14003



Scollaperiosteo
Molt
TD14005



Scollaperiosteo
Williger tagliente 14 cm
TD13307



Scollaperiosteo
Williger smusso 16 cm
TD13308

MANICI PER BISTURI

Bistouri handle



Rotondo
fig. 5
TD12102



Rotondo
fig. 5/A
TD12103



fig. 7
TD12101



fig. 3
millimetrato
TD12105



fig. 3
TD12104

Forbici / Scissor



TD13100 - iris dritte



TD13101 - iris curve



TD12802 - Goldman Fox dritte



TD12801 - Goldman Fox curve



TD12706 - Noyes-Castroviejo dritte



TD12705 - Noyes-Castroviejo curve



TD12701 - Beebee dritte



TD12700 - Beebee curve

Porta aghi / Needle holders



TD12809 - Castroviejo cm 14 retto



TD12808 - Castroviejo cm 14 curvo



TD12806 - Mayo-Hegar cm 16



TD12812 - Crile-Wood cm 15



TD12805 - Mathieu cm 14



TD12809TC - Castroviejo cm 14 - retto - Tungsten Carbide



TD12808TC - Castroviejo cm 14 - curvo - Tungsten Carbide



TD12806TC - Mayo-Hegar cm 16 - Tungsten Carbide



TD12812TC - Crile-Wood cm 15 - Tungsten Carbide

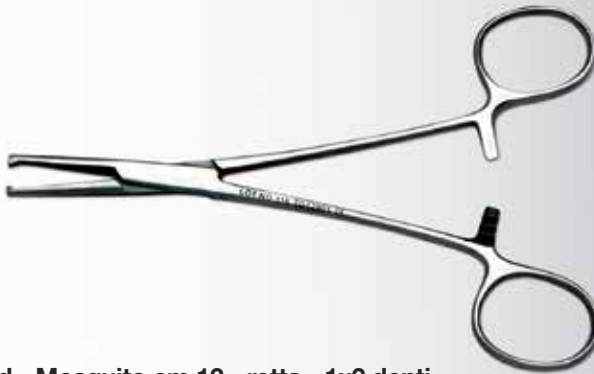

TD12805TC - Mathieu cm 14 - Tungsten Carbide

Pinze emostatiche / Haemostatic forceps**TD12903 - Halstead - Mosquito cm 12 - retta****TD12902 - Halstead - Mosquito cm 12 - curva****TD12901 - Halstead - Mosquito cm 12 - retta - 1x2 denti**



TD12900 - Halstead - Mosquito cm 12 - curva - 1x2 denti

Pinze ossivore / Bones forceps



TD14305 - Blumenthal standard



TD14304 - Blumenthal 30°

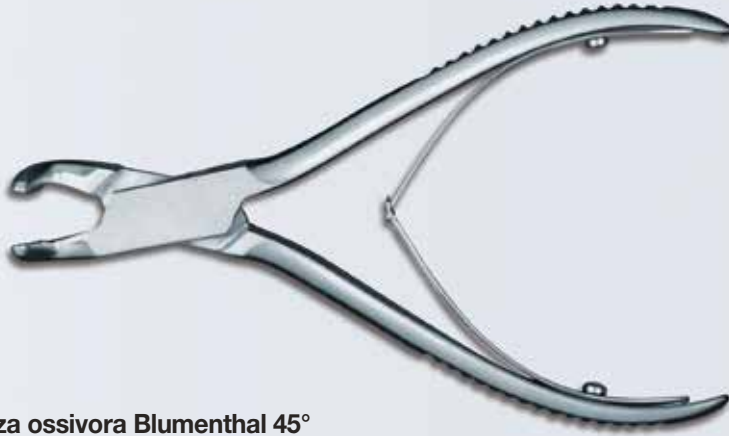

TD14303 - Pinza ossivora Blumenthal 45°



TD14300 - Pinza ossivora Luer



TD14310 - Pinza ossivora Friedman



TD14312 - Pinza ossivora Beyer con snodi

Leve per radici / *Roots elevators*



TD12001 - Flohr 1



TD12002 - Flohr 2



TD12003 - Flohr 2 Apicale



TD12004 - Flohr 4 Apicale



TD12005 - Flohr - Hylin 5 Apicale



TD12006 - Flohr - Hylin 6 Apicale



TD12007 - Bein 2 mm



TD12008 - Bein 3 mm



TD12009 - Bein 4 mm



TD12010 - Bein 2 mm



TD12011 - Bein 3 mm



TD12012 - Bein 4 mm



TD12013 - Bein 2 mm



TD12014 - Bein 3 mm



TD12015 - Bein 4 mm



TD12028 - Cryer 26



TD12029 - Cryer 25



TD12030 - Cryer 45



TD12031 - Cryer 44

Pinze per frammenti / Root fragment forceps



TD14315 - Stieglitz per frammenti di radici superiori



TD14316 - Stieglitz per frammenti di radici inferiori

Pinze per estrazione / Forceps for extraction



TD11001 - Fig. 1 per incisivi e canini superiori



TD11002 - Fig. 2 per incisivi e canini superiori



TD11004 - Fig. 7 per premolari superiori



TD11014 - Fig. 17 per molari superiori - Lato sinistro



TD11015 - Fig. 18 per molari superiori - Lato destro



TD11010 - Fig. 67 per denti del giudizio superiori



TD11007 - Fig. 51 per radici superiori



TD11008 - Fig. 51A per radici superiori



TD11003 - Fig. 4 per incisivi e canini inferiori



TD11005 - Fig. 13 per premolari inferiori



TD11016 - Fig. 21 per molari inferiori



TD11017 - Fig. 22 per molari inferiori



TD11028 - Fig. 86 per molari inferiori



TD11026 - Fig. 79 per denti del giudizio inferiori



TD11020 - Fig. 33 per radici inferiori



TD11012- Fig. 74 per radici inferiori



TD11022 - Fig. 45 per radici inferiori



TD11023 - per separare Fig. 54 per superiori



TD11024 - per separare Fig. 56 per inferiori

Porta matrici / *matrix retainers*



TD11030 - Tofflemire porta matrici universale - *Tofflemire universal matrix retainer*



TD11031 Nystrom porta matrici destra - *Nystrom matrix retainer right*



TD11032 Nystrom porta matrici sinistra - *Nystrom matrix retainer left*



FRESE DIAMANTATE
DIAMOND BURS



Le frese diamantate Dental Market sono state studiate e prodotte per offrire le massime prestazioni, in termini di affidabilità, precisione, durata, qualità di taglio ecc.

Lo stelo è perfettamente bilanciato e garantisce un supporto ideale, riducendo notevolmente le vibrazioni ed allungando la vita delle Vostre turbine.

La diamantatura, effettuata con le tecniche più moderne, prevede l'impiego di diamante naturale accuratamente selezionato (De Beers), che garantisce una granulometria uniforme dei cristalli e un taglio più efficace rispetto al diamante sintetico inoltre, grazie alla scelta di una granulometria particolare, le frese Dental Market offrono la massima efficienza di taglio con sviluppo di temperature inferiori.

Il trattamento di produzione innovativo e l'utilizzo di un particolare legante permettono pertanto di ottenere una fresa con doppio strato di diamante per una durata maggiore dello strumento. Tutto ciò viene dimostrato dai numerosi test, che quotidianamente vengono effettuati, con l'ausilio di apparecchiature elettroniche altamente tecnologiche che permettono di valutare il comportamento delle frese in condizioni di massimo stress durante la fase lavorativa.

In una realtà dove la salute, il benessere, l'estetica del paziente assumono un'importanza notevole è assolutamente indispensabile utilizzare uno strumentario efficace e di ottima qualità.

Le frese diamantate Dental Market sono disponibili con grana particolare per monconizzazione atraumatica di denti vitali, con grana grossa per demolizioni rilevanti, con grana fine per la rifinitura della preparazione, con micrograna per lucidatura di compositi.



The Dental Market diamond burs have been designed and manufactured to deliver maximum performance, reliability, accuracy, durability, cut quality etc..

The rod is perfectly balanced and provides an ideal support, significantly reducing vibration and extending the life of your turbine. The dressing, made with modern techniques, involving the use of carefully selected natural diamonds (De Beers), which guarantees a uniform grain size of crystals and cut more effective than synthetic diamond also, thanks to the choice of a particular particle size, Dental Market cutters provide maximum cutting efficiency with the development of lower temperatures.

Treatment of innovative production and use of a particular ligand allow therefore to obtain a diamond cutter with double-layer for a longer period of the instrument. All this is demonstrated by numerous tests that are performed daily, using high-tech electronic equipment which allow to assess the behavior of the drills in conditions of maximum stress during the work.

In an environment where the health, welfare, aesthetics of the patient is of great importance is absolutely essential to use an effective, high quality instruments.

The drills diamond Dental Market are available with particular grain for traumatic maiming of vital teeth, with coarse material for demolition, with fine finishing preparation, with micro-grain for polishing of composites.

Codifica numerica ISO degli strumenti diamantati
ISO Numbering System

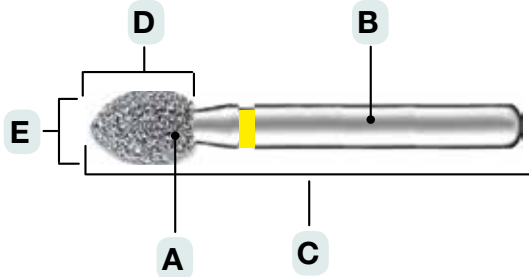

A + **B** + **C** + **D** + **E**

ISO 806 314 257 524 018

VELOCITÀ DI ROTAZIONE / ROUND SPEEDS		
DIAMETRO PEZZO LAVOR. ISO ø(1/10 mm)	MAX N. GIRI (min ⁻¹)	N. GIRI CONSIGLIATO (min ⁻¹)
007 - 010	450.000	100.000 - 220.000
012 - 014	450.000	70.000 - 220.000
016 - 018	450.000	55.000 - 160.000
021 - 023	300.000	40.000 - 120.000
025 - 027	160.000	35.000 - 110.000
029 - 031	140.000	30.000 - 95.000
033 - 040	120.000	25.000 - 75.000
042 - 050	95.000	15.000 - 60.000
055 - 070	60.000	12.000 - 40.000
080 - 100	45.000	10.000 - 20.000
N. DI GIRI CONSIGLIATO PER LE GRANE F e		
F	40.000	10.000 - 20.000
SF	30.000	8.000 - 15.000

A	Materiale della Parte Lavorante Material of the working part	806 = Diamante, legante metallico galvanico 806 = Diamond, galvanic metal bond
B	Tipo di attacco Shank and overall length	314 = FG attacco standard da 19mm e ø 1,6 mm 314 = FG Shank standard 19mm, ø 1.60mm
C	Forma della fresa in base (ISO 6360-2) Shape (ISO 6360-2)	257= Football 257= Pointed Bud
D	Granulometria di lavorazione Grit size/cut	524 = Granulometria dimensioni standard 524 = Grit size standard
E	Dimensione Nominale Nominal size	ISO 2157 Larghezza del diametro della parte lavorante (1/10 mm) 018 =Size1.8mm ISO 2157 Largest head diameter of the working part (1/10 mm) 018 =Size1.8mm

TIPO DI ATTACCO / DATA OF SHANKS			
TIPOLOGIA / TYPES	Ø		ISO
FG	1,6 mm	19 mm	314
FGL	1,6 mm	21 mm	315
FGXL	1,6 mm	25 mm	316
RA / CA / W	2,35 mm	22 mm	204
HP / HP / H	2,35 mm	44,5 mm	104

DIMENSIONI GRANULOMETRIA DIAMANTE • DIAMOND GRIT SIZES

granulometria grit de nition	abbreviazione abbreviation		dimensioni grani / μ grit size / μ		colore anello ring markings	N° ISO ISO No.
super-grossa super-coarse	SG		181		nero black	544
grossa coarse	G		151		verde green	534
media medium	M		107			524
fine fine	F		40		rosso red	514
super fine super-fine	SF		20		giallo yellow	504

PITTOGRAMMA / PICTOGRAPHS



Preparazione cavità
Cavity preparation



Preparazione coronarie
Crown preparation



Lavorazione su otturazione
Working on fillings



Rimuovi Otturazione
Removal of old fillings



Numero ISO
ISO No.



Riferimento ordine prodotto
Order No.



Velocità di Rotazione consigliata
Speed recommendation



Velocità di rotazione MAX
Maximum permissible speed



Numero di frese per scatola
Number of pieces per box

ESEMPIO ORDINE / ORDER EXAMPLE

801 (001)



Pallina
Spherical
(Round)

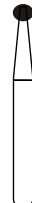

016

Diam./Size \varnothing 1/10 mm

Lungh./Length in mm

Shank No. ISO ORDER No.

FG 806 314 001 524 ... **801...M** **016 1** *

REF ORDINE **801 016 M**

* **1-2-3: GRUPPO / GROUP**

Vari tipi di preparazione corona
Various types of crown preparation

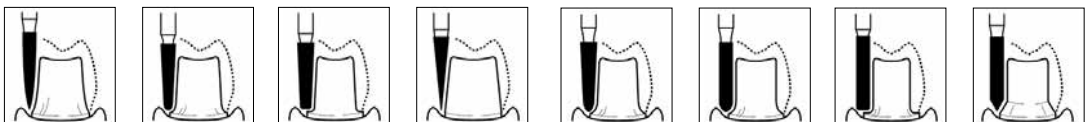

- -M- ISO 524 (110-120 µm) Senza Anello/Without Ring • MEDIA / STANDARD
- -SG- ISO 544 (180 µm) Anello Nero/Black Ring • SUPERGROSSA/SUPERCOARSE
- -G- ISO 534 (135 µm) Anello Verde/Green Ring • GROSSA / COARSE
- -F- ISO 514 (50 µm) Anello Rosso/Red Ring • FINE / FINE
- -SF- ISO 504 (30 µm) Anello Giallo/Yellow Ring • SUPERFINE / SUPERFINE

801 (001)



Pallina
Spherical (Round)

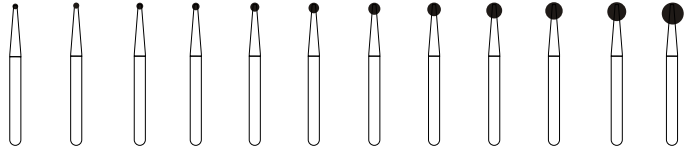

Diam./Size \varnothing 1/10 mm

Lungh./Length in mm

007 008 009 010 012 014 016 018 021 023 025 029

Shank ISO REF ORDINE N°

FG 806 314 001 524 ... **801...M**

007₁ 008₁ 009₁ 010₁ 012₁ 014₁ 016₁ 018₂ 021₂ 023₂ 025₂ 029₂

FG 806 314 001 544 ... **801...SG**

012₂ 014₂ 016₂ 018₂ 021₂ 023₂ 025₂ 029₂

FG 806 314 001 534 ... **801...G**

012₂ 014₂ 016₂ 018₂ 021₂ 023₂ 025₂ 029₂

FG 806 314 001 514 ... **801...F**

007₂ 008₂ 009₂ 010₂ 012₂ 014₂ 016₂ 018₂ 021₂ 023₂ 025₂ 029₂

FG 806 314 001 504 ... **801...SF**

012₂ 014₂ 016₂ 018₂ 021₂ 023₂ 025₂ 029₂

801L (697)



Pallina, lunga
Spherical, extra long neck

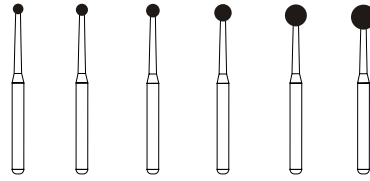

Diam./Size \varnothing 1/10 mm

Lungh./Length in mm

014 016 018 023 029 033

Shank ISO REF ORDINE N°

FG 806 314 697 524 ... **801L...M**

014₂ 016₂ 018₂ 023₂ 029₂ 033₂

FG 806 314 697 544 ... **801L...SG**

014₃ 016₃ 018₃ 023₃ 029₃

FG 806 314 697 534 ... **801L...G**

014₃ 016₃ 018₃ 023₃ 029₃

802 (002)



Pallina con collare
Ball collar

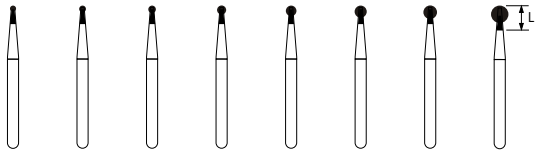

Diam./Size \varnothing 1/10 mm

Lungh./Length in mm

008 009 010 012 014 016 018 023

2,45 2,45 2,45 2,45 2,45 2,45 2,45 3,20

Shank ISO REF ORDINE N°

FG 806 314 002 524 ... **802...M**

008₁ 009₁ 010₁ 012₁ 014₁ 016₁ 018₂ 023₂

FG 806 314 002 544 ... **802...SG**

014₂ 016₂ 018₃ 023₃

FG 806 314 002 534 ... **802...G**

012₂ 014₂ 016₂ 018₃ 023₃

FG 806 314 002 514 ... **802...F**

016₂

*1-2-3: GRUPPO / GROUP

- M- ISO 524 (110-120 µm) Senza Anello/Without Ring • MEDIA / STANDARD
- SG- ISO 544 (180 µm) Anello Nero/Black Ring • SUPERGROSSA/SUPERCOARSE
- G- ISO 534 (135 µm) Anello Verde/Green Ring • GROSSA / COARSE
- F- ISO 514 (50 µm) Anello Rosso/Red Ring • FINE / FINE
- SF- ISO 504 (30 µm) Anello Giallo/Yellow Ring • SUPERFINE / SUPERFINE

805 (010)



Cono rovesciato
Inverted cone



Diam./Size ø 1/10 mm		007	008	009	010	012	014	016	018	021	023	
Lungh./Length in mm		1,0	1,0	1,0	1,0	1,2	1,6	1,6	1,6	1,9	2,5	
■ Shank	ISO REF ORDINE N°											
 FG	806 314 010 524 ... 805...M	007 ₁	008 ₁	009 ₁	010 ₁	012 ₁	014 ₁	016 ₁	018 ₂	021 ₂	023 ₂	
 FG	806 314 010 544 ... 805...SG							014 ₂	016 ₂	018 ₃	021 ₃	023 ₃
 FG	806 314 010 534 ... 805...G					012 ₂	014 ₂	016 ₂	018 ₃	021 ₃		
 FG	806 314 010 514 ... 805...F							014 ₂	016 ₂			

806 (019)



Cono rovesciato con collare
Inverted cone collar

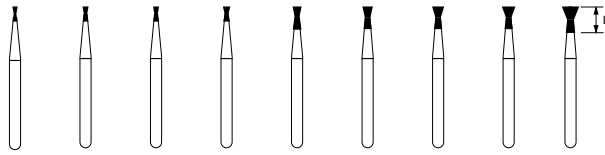

Diam./Size ø 1/10 mm		007	008	009	010	012	014	016	018	023	
Lungh./Length in mm		2,0	2,0	2,0	2,0	3,0	3,0	3,0	3,0	4,0	
■ Shank	ISO REF ORDINE N°										
 FG	806 314 019 524 ... 806...M	007 ₁	008 ₁	009 ₁	010 ₁	012 ₁	014 ₁	016 ₁	018 ₂	023 ₂	
 FG	806 314 019 544 ... 806...SG						014 ₂	016 ₂	018 ₃		
 FG	806 314 019 534 ... 806...G				010 ₂	012 ₂	014 ₂	016 ₂	018 ₃	023 ₃	

807 (225)



Cono rovesciato
Inverted Cone

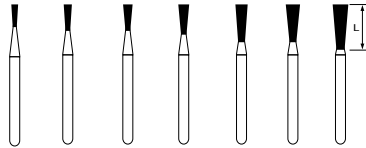

Diam./Size ø 1/10 mm		010	012	014	016	018	021	023	
Lungh./Length		3,0	3,5	3,5	4,0	5,0	5,0	6,0	
■ Shank	ISO REF ORDINE N°								
 FG	806 314 225 524 ... 807...M	010 ₁	012 ₁	014 ₁	016 ₁	018 ₂	021 ₂	023 ₂	
 FG	806 314 225 544 ... 807...SG						016 ₂		
 FG	806 314 225 534 ... 807...G			012 ₂	014 ₂	016 ₂	018 ₃	021 ₃	
 FG	806 314 225 514 ... 807...F			012 ₂	016 ₂				

807L (226)



Cono rovesciato lungo
Inverted Cone, long



Diam./Size		018
Lungh./Length		7,0
■ Shank	ISO REF ORDINE N°	
 FG	806 314 226 524 ... 807L...M	018 ₂

*1-2-3: GRUPPO / GROUP

- M- ISO 524 (110-120 µm) Senza Anello/Without Ring • MEDIA / STANDARD
- SG- ISO 544 (180 µm) Anello Nero/Black Ring • SUPERGROSSA/SUPERCOARSE
- G- ISO 534 (135 µm) Anello Verde/Green Ring • GROSSA / COARSE
- F- ISO 514 (50 µm) Anello Rosso/Red Ring • FINE / FINE
- SF- ISO 504 (30 µm) Anello Giallo/Yellow Ring • SUPERFINE / SUPERFINE

808 (014)

3 Cono rovesciato
Inverted Cone

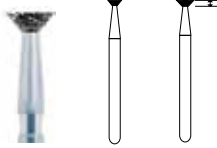

Diam./Size ø 1/10 mm		018	023
Lungh./Length in mm		0,7	0,8
Shank	ISO	REF	ORDINE N°
FG	806 314 014 524 ...	808...M	018 ₂ 023 ₂
FG	806 314 014 534 ...	808...G	023 ₃

809 (019)

3 Cono rovesciato con collare
Inverted Cone with Collar



Diam./Size ø 1/10 mm		018	023
Lungh./Length in mm		2,0	2,5
Shank	ISO	REF	ORDINE N°
FG	806 314 019 524 ...	809...M	018 ₂ 023 ₂

811 (038)

3 Barile
Barrel



Diam./Size ø 1/10 mm		033	037
Lungh./Length in mm		4,2	7,0
Shank	ISO	REF	ORDINE N°
FG	806 314 038 524 ...	811...M	033 ₃ 037 ₃
FG	806 314 038 544 ...	811...SG	033 ₃ 037 ₃
FG	806 314 038 534 ...	811...G	033 ₃ 037 ₃

813 (023)

3 Fresa per amalgama
Amalgam Remover

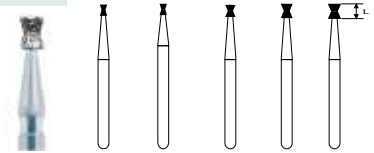

Diam./Size ø 1/10 mm		010	012	014	016	018
Lungh./Length in mm		1,5	1,5	1,5	2,0	2,0
Shank	ISO	REF	ORDINE N°			
FG	806 314 023 524 ...	813...M	010 ₂	012 ₂	014 ₂	016 ₂ 018 ₂
FG	806 314 023 544 ...	813...SG				016 ₃ 018 ₃
FG	806 314 023 534 ...	813...G	012 ₃	014 ₃	016 ₃	018 ₃

813L (523)

3 Fresa per amalgama
Amalgam Remover



Diam./Size/Taille ø 1/10 mm		014	016
Lungh./Length in mm		3,0	3,0
Shank	ISO	REF	ORDINE N°
FG	806 314 523 524 ...	813L...M	014 ₃ 016 ₃
FG	806 314 523 534 ...	813L...G	014 ₃ 016 ₃

815 (040)

3 Ruota
Wheel

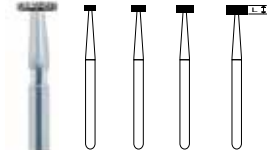

Diam./Size ø 1/10 mm		018	023	027	033
Lungh./Length in mm					
Shank	ISO	REF	ORDINE N°		
FG	806 314 040 524 ...	815...M	018 ₃	023 ₃	027 ₃ 033 ₃
FG	806 314 040 534 ...	815...G	018 ₃	023 ₃	027 ₃ 033 ₃

*1-2-3: GRUPPO / GROUP

- -M- ISO 524 (110-120 µm) Senza Anello/Without Ring • MEDIA / STANDARD
- -SG- ISO 544 (180 µm) Anello Nero/Black Ring • SUPERGROSSA/SUPERCOARSE
- -G- ISO 534 (135 µm) Anello Verde/Green Ring • GROSSA / COARSE
- -F- ISO 514 (50 µm) Anello Rosso/Red Ring • FINE / FINE
- -SF- ISO 504 (30 µm) Anello Giallo/Yellow Ring • SUPERFINE / SUPERFINE

820 (043)



Diam./Size ø 1/10 mm	033 040
Lungh./Length in mm	2,0 2,0

Shank	ISO	REF	ORDINE N°
FG	806 314 043 524 ...	820...M	033 ₃ 040 ₃
FG	806 314 043 534 ...	820...G	033 ₃ 040 ₃

822 (237)



Diam./Size ø 1/10 mm	008 009 010 012
Lungh./Length in mm	2,0 2,0 2,0 3,0

Shank	ISO	REF	ORDINE N°
FG	806 314 237 524 ...	822...M	008 ₁ 009 ₁ 010 ₁ 012 ₁
FG	806 314 237 544 ...	822...SG	012 ₂
FG	806 314 237 534 ...	822...G	008 ₂ 009 ₂ 010 ₂ 012 ₂
FG	806 314 237 514 ...	822...F	008 ₂ 009 ₂ 012 ₂

825 (304)



Diam./Size ø 1/10 mm	018 023 025 033
Lungh./Length in mm	0,8 0,9 0,9 1,5

Shank	ISO	REF	ORDINE N°
FG	806 314 304 524 ...	825...M	018 ₂ 023 ₂ 025 ₂ 033 ₂
FG	806 314 304 534 ...	825...G	023 ₃ 033 ₃

830 (238)

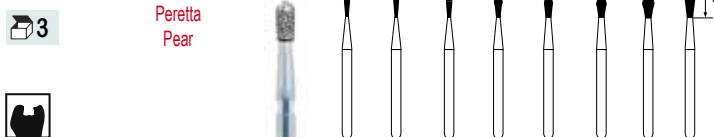

Diam./Size ø 1/10 mm	008 009 010 012 014 016 018 021
Lungh./Length in mm	2,5 2,7 2,7 2,7 2,7 2,7 2,7 5,1

Shank	ISO	REF	ORDINE N°
FG	806 314 238 524 ...	830...M	008 ₁ 009 ₁ 010 ₁ 012 ₁ 014 ₁ 016 ₁ 018 ₁ 021 ₁
FG	806 314 238 544 ...	830...SG	012 ₂ 014 ₂ 016 ₂ 018 ₂ 021 ₂
FG	806 314 238 534 ...	830...G	010 ₂ 012 ₂ 014 ₂ 016 ₂ 018 ₂ 021 ₂
FG	806 314 238 514 ...	830...F	008 ₂ 010 ₂ 012 ₂ 014 ₂
FG	806 314 238 504 ...	830...SF	012 ₂

830L (239)



Diam./Size ø 1/10 mm	012 014 016 018 021 025
Lungh./Length in mm	4,0 5,0 5,0 5,0 5,0 7,0

Shank	ISO	REF	ORDINE N°
FG	806 314 239 524 ...	830L...M	012 ₃ 014 ₃ 016 ₃ 018 ₃ 021 ₃ 025 ₃
FG	806 314 239 544 ...	830L...SG	014 ₃ 016 ₃ 018 ₃ 021 ₃ 025 ₃
FG	806 314 239 534 ...	830L...G	012 ₃ 014 ₃ 016 ₃ 018 ₃ 021 ₃ 025 ₃
FG	806 314 239 514 ...	830L...F	012 ₃ 014 ₃ 016 ₃
FG	806 314 239 504 ...	830L...SF	014 ₃

*1-2-3: GRUPPO / GROUP

- M- ISO 524 (110-120 µm) Senza Anello/Without Ring • MEDIA / STANDARD
- SG- ISO 544 (180 µm) Anello Nero/Black Ring • SUPERGROSSA/SUPERCOARSE
- G- ISO 534 (135 µm) Anello Verde/Green Ring • GROSSA / COARSE
- F- ISO 514 (50 µm) Anello Rosso/Red Ring • FINE / FINE
- SF- ISO 504 (30 µm) Anello Giallo/Yellow Ring • SUPERFINE / SUPERFINE

833 (466)



Per modellazione occlusale
For modeling occlusal

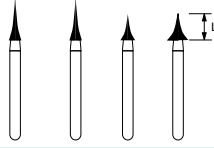

Diam./Size ø 1/10 mm

016 018 021 031

Lungh./Length in mm

5,9 5,9 3,5 3,5

Shank	ISO	REF	ORDINE N°
FG	806 314 466 524 ...	833...M	016 ₂ 018 ₂ 021 ₂ 031 ₂
FG	806 314 466 514 ...	833...F	016 ₃ 018 ₃ 021 ₃ 031 ₃
FG	806 314 466 504 ...	833...SF	016 ₃ 018 ₃ 021 ₃ 031 ₃

834 (552)



Marcatore di profondità
Depth Marker

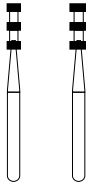

Diam./Size ø 1/10 mm

016 021

Lungh./Length in mm

6,0 6,0

Shank	ISO	REF	ORDINE N°
FG	806 314 552 524 ...	834...M	016 ₃ 021 ₃

834A (000)



Marcatore di profondità
Depth Marker



Diam./Size ø 1/10 mm

031

Lungh./Length in mm

3,5

Shank	ISO	REF	ORDINE N°
FG	806 314 000 524 ...	834A...M	031 ₃

835 (107)



Cilindro
Cylinder

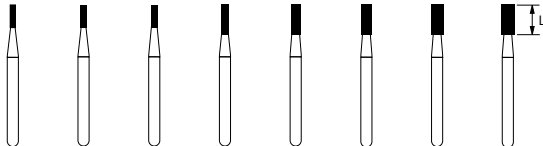

Diam./Size ø 1/10 mm

007 008 009 010 012 014 016 018

Lungh./Length in mm

3,0 3,0 3,0 4,0 4,0 4,0 4,0 4,0

Shank	ISO	REF	ORDINE N°
FG	806 314 107 524 ...	835...M	007 ₁ 008 ₁ 009 ₁ 010 ₁ 012 ₁ 014 ₁ 016 ₁ 018 ₁
FG	806 314 107 544 ...	835...SG	010 ₂ 012 ₂ 014 ₂ 016 ₂
FG	806 314 107 534 ...	835...G	010 ₂ 012 ₂ 014 ₂ 016 ₂ 018 ₂
FG	806 314 107 514 ...	835...F	010 ₂ 012 ₂ 014 ₂
FG	806 314 107 504 ...	835...SF	012 ₂

*1-2-3: GRUPPO / GROUP

- -M- ISO 524 (110-120 µm) Senza Anello/Without Ring • MEDIA / STANDARD
- -SG- ISO 544 (180 µm) Anello Nero/Black Ring • SUPERGROSSA/SUPERCOARSE
- -G- ISO 534 (135 µm) Anello Verde/Green Ring • GROSSA / COARSE
- -F- ISO 514 (50 µm) Anello Rosso/Red Ring • FINE / FINE
- -SF- ISO 504 (30 µm) Anello Giallo/Yellow Ring • SUPERFINE / SUPERFINE

835KR (156)

 3 Cilindro bordi arrotondati
Round Edge Cylinder

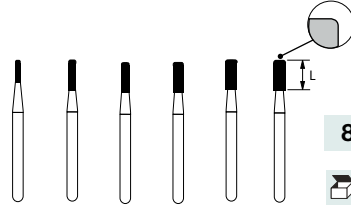

Diam./Size ø 1/10 mm 008 010 012 014 016 018

Lungh./Length in mm 3,0 4,0 4,0 4,0 4,0 4,0

Shank	ISO	REF	ORDINE N°
□ FG	806 314 156 524 ...	835KR...M	008 ₁ 010 ₁ 012 ₁ 014 ₁
■ FG	806 314 156 544 ...	835KR...SG	014 ₂ 016 ₂
■ FG	806 314 156 534 ...	835KR...G	010 ₂ 012 ₂ 014 ₂ 016 ₂ 018 ₂
■ FG	806 314 156 514 ...	835KR...F	008 ₂ 010 ₂ 012 ₂

868A (000)

 3 Marcatore di profondità
Depth Marker

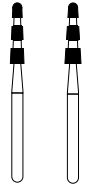

Diam./Size ø 1/10 mm 018 021

Lungh./Length in mm 8,0 8,0

Shank	ISO	REF	ORDINE N°
□ FG	806 314 000 524 ...	868A...M	018 ₃ 021 ₃

836 (110)

 3 Cilindro
Cylinder

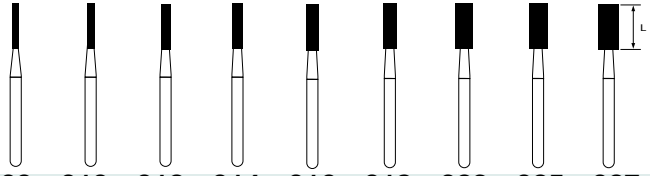

Diam./Size ø 1/10 mm 009 010 012 014 016 018 023 025 027

Lungh./Length in mm 6,0 6,0 6,0 6,0 6,0 6,0 6,0 6,0 6,0

Shank	ISO	REF	ORDINE N°
□ FG	806 314 110 524 ...	836...M	009 ₁ 010 ₁ 012 ₁ 014 ₁ 016 ₁ 018 ₂ 023 ₂ 025 ₂
■ FG	806 314 110 544 ...	836...SG	012 ₂ 014 ₂ 016 ₂ 027 ₃
■ FG	806 314 110 534 ...	836...G	010 ₂ 012 ₂ 014 ₂ 016 ₂ 018 ₃ 023 ₃ 025 ₃
■ FG	806 314 110 514 ...	836...F	010 ₂ 012 ₂

836KR (157)

 3 Cilindro bordi arrotondati
Round Edge Cylinder

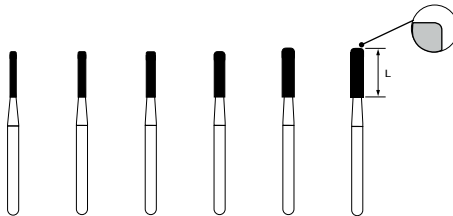

Diam./Size ø 1/10 mm 008 010 012 014 016 018

Lungh./Length in mm 6,0 6,0 6,0 6,0 6,0 6,0

Shank	ISO	REF	ORDINE N°
□ FG	806 314 157 524 ...	836KR...M	008 ₁ 010 ₁ 012 ₁ 014 ₁ 016 ₁ 018 ₂
■ FG	806 314 157 544 ...	836KR...SG	014 ₂ 016 ₂
■ FG	806 314 157 534 ...	836KR...G	010 ₂ 012 ₂ 014 ₂ 016 ₂ 018 ₃
■ FG	806 314 157 514 ...	836KR...F	008 ₂ 010 ₂ 012 ₂

*1-2-3: GRUPPO / GROUP

- M- ISO 524 (110-120 µm) Senza Anello/Without Ring • MEDIA / STANDARD
- SG- ISO 544 (180 µm) Anello Nero/Black Ring • SUPERGROSSA/SUPERCOARSE
- G- ISO 534 (135 µm) Anello Verde/Green Ring • GROSSA / COARSE
- F- ISO 514 (50 µm) Anello Rosso/Red Ring • FINE / FINE
- SF- ISO 504 (30 µm) Anello Giallo/Yellow Ring • SUPERFINE / SUPERFINE

837 (111)



Cilindro
Cylinder



Diam./Size \varnothing 1/10 mm

Lungh./Length in mm

Shank	ISO	REF	ORDINE N°
 FG	806 314 111 524 ...	837...M	
 FG	806 314 111 544 ...	837...SG	
 FG	806 314 111 534 ...	837...G	
 FG	806 314 111 514 ...	837...F	

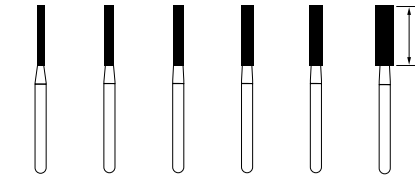

010	012	014	016	018	025
8,0	8,0	8,0	8,0	8,0	8,0

010 ₂	012 ₂	014 ₂	016 ₂	018 ₂	025 ₂
	012 ₃	014 ₃	016 ₃	018 ₃	
010 ₃	012 ₃	014 ₃	016 ₃	018 ₃	
	012 ₃	014 ₃			

837KR (158)



Cilindro bordi arrotondati
Round Edge Cylinder



Diam./Size \varnothing 1/10 mm

Lungh./Length in mm

Shank	ISO	REF	ORDINE N°
 FG	806 314 158 524 ...	837KR...M	
 FG	806 314 158 544 ...	837KR...SG	
 FG	806 314 158 534 ...	837KR...G	
 FG	806 314 158 514 ...	837KR...F	

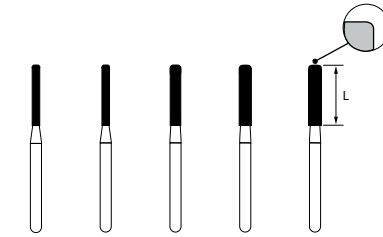

010	012	014	016	018
8,0	8,0	8,0	8,0	8,0

010 ₂	012 ₂	014 ₂	016 ₂	018 ₂
	012 ₃	014 ₃	016 ₃	018 ₃
010 ₃	012 ₃	014 ₃	016 ₃	018 ₃
010 ₃	012 ₃	014 ₃	016 ₃	

837L (112)



Cilindro lungo
Zylinder lang



Diam./Size \varnothing 1/10 mm

Lungh./Length in mm

Shank	ISO	REF	ORDINE N°
 FG	806 314 112 524 ...	837L...M	
 FG	806 314 112 544 ...	837L...SG	
 FG	806 314 112 534 ...	837L...G	
 FG	806 314 112 514 ...	837L...F	

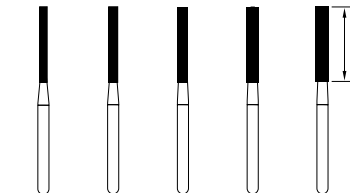

010	012	014	016	018
10,0	10,0	10,0	10,0	10,0

010 ₃	012 ₃	014 ₃	016 ₃	018 ₃
		014 ₃	016 ₃	
010 ₃	012 ₃	014 ₃	016 ₃	018 ₃
	012 ₃			

*1-2-3: GRUPPO / GROUP

- M- ISO 524 (110-120 µm) Senza Anello/Without Ring • MEDIA / STANDARD
- SG- ISO 544 (180 µm) Anello Nero/Black Ring • SUPERGROSSA/SUPERCOARSE
- G- ISO 534 (135 µm) Anello Verde/Green Ring • GROSSA / COARSE
- F- ISO 514 (50 µm) Anello Rosso/Red Ring • FINE / FINE
- SF- ISO 504 (30 µm) Anello Giallo/Yellow Ring • SUPERFINE / SUPERFINE

838 (137)

3

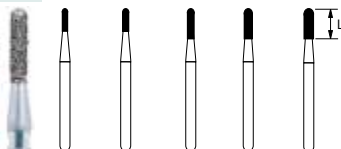
Cilindro bordi arrotondati
Round Edge CylinderDiam./Size \varnothing 1/10 mm 008 009 010 012 014

Lungh./Length in mm 3,0 3,0 4,0 4,0 4,0

Shank ISO REF ORDINE N° FG 806 314 137 524 ...838...M 008₁ 009₁ 010₁ 012₁ 014₁ FG 806 314 137 544 ...838...SG 012₂ FG 806 314 137 534 ...838...G 010₂ 012₂ 014₂ FG 806 314 137 514 ...838...F 010₂

842 (113)

3

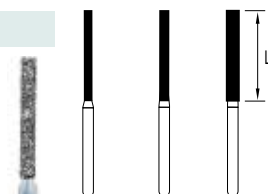
Cilindro
CylinderDiam./Size \varnothing 1/10 mm 012 014 018

Lungh./Length in mm 12,0 12,0 12,0

Shank ISO REF ORDINE N° FG 806 314 113 524 ...842...M 012₂ 014₂ 018₂ FG 806 314 113 544 ...842...SG 012₃ 014₃ 018₃ FG 806 314 113 534 ...842...G 012₃ 014₃ 018₃

845 (170)

3

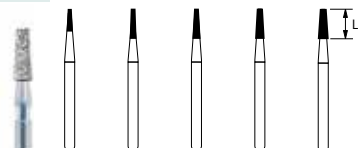
Cono troncato
Flat End TaperDiam./Size \varnothing 1/10 mm 009 010 012 014 016

Lungh./Length in mm 3,0 4,0 4,0 4,0 4,0

Shank ISO REF ORDINE N° FG 806 314 170 524 ...845...M 009₁ 010₁ 012₁ 014₁ 016₁ FG 806 314 170 534 ...845...G 012₂ 014₂ 016₂

845KR (544)

3

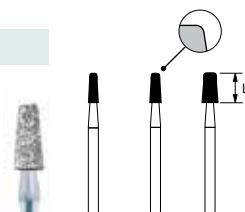
Cono con bordo arrotondato
Round Edge TaperDiam./Size \varnothing 1/10 mm 016 018 025

Lungh./Length in mm 4,0 4,0 4,0

Shank ISO REF ORDINE N° FG 806 314 544 524 ...845KR...M 016₁ 018₁ 025₁ FG 806 314 544 534 ...845KR...G 016₂ 018₂ 025₂ FG 806 314 544 514 ...845KR...F 016₂ 018₂ 025₂ FG 806 314 544 504 ...845KR...SF 025₂

*1-2-3: GRUPPO / GROUP / GROUPE / GRUPPE

- M- ISO 524 (110-120 µm) Senza Anello/Without Ring • MEDIA / STANDARD
- SG- ISO 544 (180 µm) Anello Nero/Black Ring • SUPERGROSSA/SUPERCOARSE
- G- ISO 534 (135 µm) Anello Verde/Green Ring • GROSSA / COARSE
- F- ISO 514 (50 µm) Anello Rosso/Red Ring • FINE / FINE
- SF- ISO 504 (30 µm) Anello Giallo/Yellow Ring • SUPERFINE / SUPERFINE

846 (171)



Cono troncato
Flat End Taper

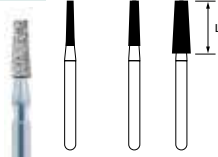

Diam./Size ø 1/10 mm	012 016 025
Lungh./Length in mm	6,0 6,0 7,0
Shank [ISO] [REF] ORDINE N°	
 FG 806 314 171 524 ... 846...M	012 ₂ 016 ₂ 025 ₂
 FG 806 314 171 534 ... 846...G	012 ₂ 016 ₂ 025 ₂
 FG 806 314 171 514 ... 846...F	025 ₂

846KR (545)



Cono con bordo arrotondato
Round Edge Taper

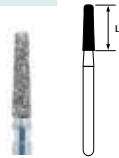

Diam./Size ø 1/10 mm	016
Lungh./Length in mm	6,0
Shank [ISO] [REF] ORDINE N°	
 FG 806 314 545 524 ... 846KR...M	016 ₂
 FG 806 314 545 534 ... 846KR...G	016 ₂
 FG 806 314 545 514 ... 846KR...F	016 ₂

847 (172)



Cono troncato
Flat End Taper

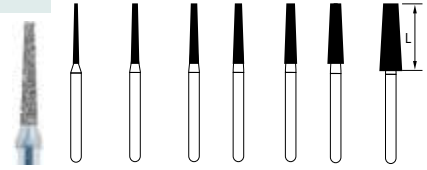

Diam./Size ø 1/10 mm	010 012 014 016 018 023 033
Lungh./Length in mm	8,0 8,0 8,0 8,0 8,0 8,0 9,0
Shank [ISO] [REF] ORDINE N°	
 FG 806 314 172 524 ... 847...M	010 ₂ 012 ₂ 014 ₂ 016 ₂ 018 ₂ 023 ₂ 033 ₂
 FG 806 314 172 544 ... 847...SG	014 ₃ 016 ₃ 018 ₃ 033 ₃
 FG 806 314 172 534 ... 847...G	010 ₃ 012 ₃ 014 ₃ 016 ₃ 018 ₃ 023 ₃
 FG 806 314 172 514 ... 847...F	010 ₃ 012 ₃ 014 ₃ 016 ₃ 023 ₃
 FG 806 314 172 504 ... 847...SF	010 ₃

847KR (546)



Cono con bordo arrotondato
Round Edge Taper

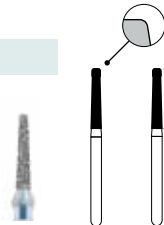

Diam./Size ø 1/10 mm	016 023
Lungh./Length in mm	8,0 8,0
Shank [ISO] [REF] ORDINE N°	
 FG 806 314 546 524 ... 847KR...M	016 ₂ 023 ₂
 FG 806 314 546 534 ... 847KR...G	016 ₃ 023 ₃
 FG 806 314 546 514 ... 847KR...F	016 ₃ 023 ₃

848 (173)



Cono troncato
Flat End Taper

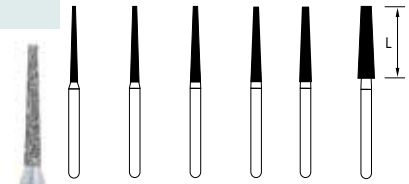

Diam./Size ø 1/10 mm	010 012 014 016 018 023
Lungh./Length in mm	10,0 10,0 10,0 10,0 10,0 10,0
Shank [ISO] [REF] ORDINE N°	
 FG 806 314 173 524 ... 848...M	010 ₂ 012 ₂ 014 ₂ 016 ₂ 018 ₂ 023 ₂
 FG 806 314 173 544 ... 848...SG	016 ₃ 018 ₃ 023 ₃
 FG 806 314 173 534 ... 848...G	010 ₃ 012 ₃ 014 ₃ 016 ₃ 018 ₃ 023 ₃
 FG 806 314 173 514 ... 848...F	010 ₃ 012 ₃ 014 ₃ 016 ₃ 018 ₃
 FG 806 314 173 504 ... 848...SF	010 ₃ 012 ₃ 014 ₃ 016 ₃

*1-2-3: GRUPPO / GROUP

- M- ISO 524 (110-120 µm) Senza Anello/Without Ring • MEDIA / STANDARD
- SG- ISO 544 (180 µm) Anello Nero/Black Ring • SUPERGROSSA/SUPERCOARSE
- G- ISO 534 (135 µm) Anello Verde/Green Ring • GROSSA / COARSE
- F- ISO 514 (50 µm) Anello Rosso/Red Ring • FINE / FINE
- SF- ISO 504 (30 µm) Anello Giallo/Yellow Ring • SUPERFINE / SUPERFINE

848L (174)

3 Cono troncato, lungo
Flat End Taper long

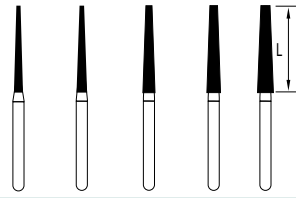

Diam./Size ø 1/10 mm	012	014	016	018	021
Lungh./Length in mm	11,5	11,5	11,5	11,5	11,5
Shank ISO REF ORDINE N°					
 FG 806 314 174 524 ... 848L...M	012 ₃	014 ₃	016 ₃	018 ₃	021 ₃
 FG 806 314 174 544 ... 848L...SG		014 ₃	016 ₃	018 ₃	021 ₃
 FG 806 314 174 534 ... 848L...G		014 ₃	016 ₃	018 ₃	

849 (196)

3 Cono a punta arrotondata
Round End Taper

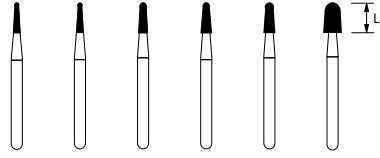

Diam./Size/Taille ø 1/10 mm	009	010	012	014	016	025
Lungh./Length in mm	4,0	4,0	4,0	4,0	4,0	4,0
Shank ISO REF ORDINE N°						
 FG 806 314 196 524 ... 849...M	009 ₁	010 ₁	012 ₁	014 ₁	016 ₁	
 FG 806 314 196 534 ... 849...G	009 ₂	010 ₂	012 ₂	014 ₂	016 ₂	025 ₂
 FG 806 314 196 514 ... 849...F			012 ₂			

850 (199)

3 Cono a punta arrotondata
Round End Taper

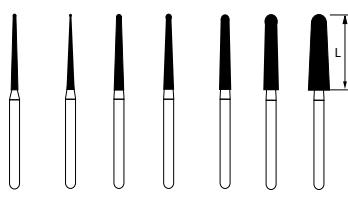

Diam./Size ø 1/10 mm	010	012	014	016	018	023	031
Lungh./Length in mm	10,0	10,0	10,0	10,0	10,0	10,0	10,0
Shank ISO REF ORDINE N°							
 FG 806 314 199 524 ... 850...M	010 ₂	012 ₂	014 ₂	016 ₂	018 ₂	023 ₂	031 ₂
 FG 806 314 199 544 ... 850...SG			014 ₃	016 ₃	018 ₃	023 ₃	
 FG 806 314 199 534 ... 850...G	010 ₃	012 ₃	014 ₃	016 ₃	018 ₃	023 ₃	031 ₃
 FG 806 314 199 514 ... 850...F	010 ₃	012 ₃	014 ₃	016 ₃	018 ₃	023 ₃	
 FG 806 314 199 504 ... 850...SF	010 ₃	012 ₃	014 ₃	016 ₃	018 ₃		

850KR (553)

3 Cono con bordo arrotondato
Round Edge Taper

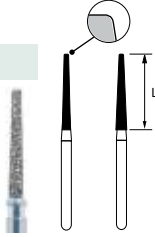







Diam./Size ø 1/10 mm	014	018
Lungh./Length in mm	10,0	10,0
Shank ISO REF ORDINE N°		
 FG 806 314 553 524 ... 850KR...M	014 ₂	018 ₂
 FG 806 314 553 544 ... 850KR...SG	14 ₃	018 ₃
 FG 806 314 553 534 ... 850KR...G	014 ₃	018 ₃

*1-2-3: GRUPPO / GROUP

- -M- ISO 524 (110-120 µm) Senza Anello/Without Ring • MEDIA / STANDARD
- -SG- ISO 544 (180 µm) Anello Nero/Black Ring • SUPERGROSSA/SUPERCOARSE
- -G- ISO 534 (135 µm) Anello Verde/Green Ring • GROSSA / COARSE
- -F- ISO 514 (50 µm) Anello Rosso/Red Ring • FINE / FINE
- -SF- ISO 504 (30 µm) Anello Giallo/Yellow Ring • SUPERFINE / SUPERFINE

850L (200)





 **3** Cono lungo con bordo arrotondato
Long Round Taper

Diam./Size ø 1/10 mm	012 014 016 018
Lungh./Length in mm	11,5 11,5 11,5 11,5
Shank [ISO] [REF] ORDINE N°	
■ FG 806 314 200 524 ... 850L...M	012 ₃ 014 ₃ 016 ₃ 018 ₃
■ FG 806 314 200 544 ... 850L...SG	014 ₃ 016 ₃ 018 ₃
■ FG 806 314 200 534 ... 850L...G	012 ₃ 014 ₃ 016 ₃ 018 ₃
■ FG 806 314 200 514 ... 850L...F	012 ₃ 014 ₃
■ FG 806 314 200 504 ... 850L...SF	014 ₃

851 (219)







 **3** Cono con punta non lavorante
Round Safe End Taper

Diam./Size ø 1/10 mm	012 014 016
Lungh./Length in mm	8,0 8,0 8,0
Shank [ISO] [REF] ORDINE N°	
■ FG 806 314 219 524 ... 851...M	012 ₃ 014 ₃ 016 ₃
■ FG 806 314 219 534 ... 851...G	012 ₃ 014 ₃ 016 ₃
■ FG 806 314 219 514 ... 851...F	012 ₃ 014 ₃

852 (164)





 **3** Cono X-mas tree

Diam./Size 1/10 mm	010 012 023 033
Lungh./Length in mm	4,0 6,0 6,0 7,0
Shank [ISO] [REF] ORDINE N°	
■ FG 806 314 164 524 ... 852...M	010 ₁ 012 ₁ 023 ₂
■ FG 806 314 164 544 ... 852...SG	023 ₂ 033 ₂
■ FG 806 314 164 534 ... 852...G	012 ₂ 023 ₂
■ FG 806 314 164 514 ... 852...F	010 ₂ 012 ₂
■ FG 806 314 164 504 ... 852...SF	010 ₂ 012 ₂

855 (197)









 **3** Cono a punta arrotondata
Round End Taper

Diam./Size ø 1/10 mm	012 014 025
Lungh./Length in mm	6,0 6,0 7,0
Shank [ISO] [REF] ORDINE N°	
■ FG 806 314 197 524 ... 855...M	012 ₁ 014 ₁ 025 ₁
■ FG 806 314 197 544 ... 855...SG	012 ₂ 014 ₂ 025 ₂
■ FG 806 314 197 534 ... 855...G	012 ₂ 014 ₂ 025 ₂
■ FG 806 314 197 514 ... 855...F	014 ₂

856 (198)

 **3** Cono a punta arrotondata
Round End Taper

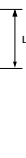









Diam./Size ø 1/10 mm	009 010 012 014 016 018 021 025
Lungh./Length in mm	8,0 8,0 8,0 8,0 8,0 8,0 8,0 8,0
Shank [ISO] [REF] ORDINE N°	
■ FG 806 314 198 524 ... 856...M	009 ₂ 010 ₂ 012 ₂ 014 ₂ 016 ₂ 018 ₂ 021 ₂ 025 ₂
■ FG 806 314 198 544 ... 856...SG	012 ₃ 016 ₃ 018 ₃ 021 ₃ 025 ₃
■ FG 806 314 198 534 ... 856...G	012 ₃ 014 ₃ 016 ₃ 018 ₃ 021 ₃ 025 ₃
■ FG 806 314 198 514 ... 856...F	009 ₃ 010 ₃ 012 ₃ 014 ₃ 016 ₃ 018 ₃ 021 ₃ 025 ₃
■ FG 806 314 198 504 ... 856...SF	010 ₃ 012 ₃ 016 ₃

*1-2-3: GRUPPO / GROUP

- -M- ISO 524 (110-120 µm) Senza Anello/Without Ring • MEDIA / STANDARD
- -SG- ISO 544 (180 µm) Anello Nero/Black Ring • SUPERGROSSA/SUPERCOARSE
- -G- ISO 534 (135 µm) Anello Verde/Green Ring • GROSSA / COARSE
- -F- ISO 514 (50 µm) Anello Rosso/Red Ring • FINE / FINE
- -SF- ISO 504 (30 µm) Anello Giallo/Yellow Ring • SUPERFINE / SUPERFINE

856L (199)

 **Cono lungo a punta arrotondata**
Long Round End Taper

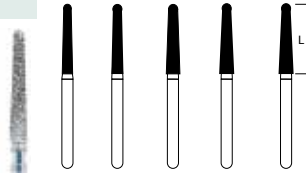

Diam./Size ø 1/10 mm	014	016	018	021	023
Lungh./Length in mm	9,0	9,0	9,0	9,0	9,0

Shank ISO REF ORDINE N°

□ FG 806 314 199 524 ... 856L...M	014 ₂	016 ₂	018 ₂	021 ₂	023 ₂
■ FG 806 314 199 544 ... 856L...SG	014 ₃	016 ₃	018 ₃	021 ₃	023 ₃
■ FG 806 314 199 534 ... 856L...G	014 ₃	016 ₃	018 ₃	021 ₃	023 ₃
■ FG 806 314 199 514 ... 856L...F	014 ₃	016 ₃	018 ₃	021 ₃	023 ₃

857 (220)

 **Cono lungo a punta arrotondata non lavorante**
Round Safe End Taper

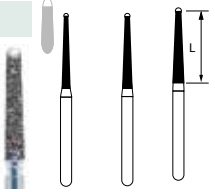

Diam./Size ø 1/10 mm	012	014	016
Lungh./Length in mm	10,0	10,0	10,0

Shank ISO REF ORDINE N°

□ FG 806 314 220 524 ... 857...M	012 ₃	014 ₃	016 ₃
■ FG 806 314 220 544 ... 857...SG		014 ₃	016 ₃
■ FG 806 314 220 534 ... 857...G	012 ₃	014 ₃	016 ₃
■ FG 806 314 220 514 ... 857...F	012 ₃	014 ₃	

858 (165)

 **Cono a punta Needle**

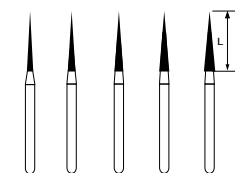

Diam./Size ø 1/10 mm	010	012	014	016	018
Lungh./Length in mm	8,0	8,0	8,0	8,0	8,0

Shank ISO REF ORDINE N°

□ FG 806 314 165 524 ... 858...M	010 ₂	012 ₂	014 ₂	016 ₂	018 ₂
■ FG 806 314 165 544 ... 858...SG			014 ₃	016 ₃	018 ₃
■ FG 806 314 165 534 ... 858...G	010 ₃	012 ₃	014 ₃	016 ₃	018 ₃
■ FG 806 314 165 514 ... 858...F	010 ₃	012 ₃	014 ₃	016 ₃	018 ₃
■ FG 806 314 165 504 ... 858...SF	010 ₃	012 ₃	014 ₃	016 ₃	

859 (166)

 **Cono a punta Needle**

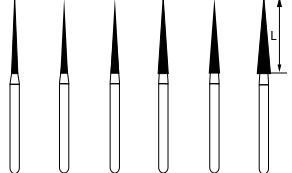

Diam./Size ø 1/10 mm	010	012	014	016	018	021
Lungh./Length in mm	10,0	10,0	10,0	10,0	10,0	10,0

Shank ISO REF ORDINE N°

□ FG 806 314 166 524 ... 859...M	010 ₂	012 ₂	014 ₂	016 ₂	018 ₂	021 ₂
■ FG 806 314 166 544 ... 859...SG					018 ₃	
■ FG 806 314 166 534 ... 859...G	010 ₃	012 ₃	014 ₃	016 ₃	018 ₃	021 ₃
■ FG 806 314 166 514 ... 859...F	010 ₃	012 ₃	014 ₃	016 ₃	018 ₃	
■ FG 806 314 166 504 ... 859...SF	010 ₃	012 ₃	014 ₃	016 ₃	018 ₃	

859L (167)

 **Cono a punta lungo Needle long**

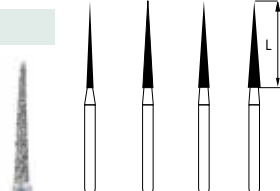

Diam./Size ø 1/10 mm	010	014	016	018
Lungh./Length in mm	11,5	11,5	11,5	11,5

Shank ISO REF ORDINE N°

□ FG 806 314 167 524 ... 859L...M	010 ₃	014 ₃	016 ₃	018 ₃
■ FG 806 314 167 544 ... 859L...SG			016 ₃	018 ₃
■ FG 806 314 167 534 ... 859L...G		014 ₃	016 ₃	018 ₃
■ FG 806 314 167 514 ... 859L...F	010 ₃	014 ₃	016 ₃	
■ FG 806 314 167 504 ... 859L...SF	010 ₃	014 ₃	016 ₃	

860 (247)

 **Fiamma Flame**

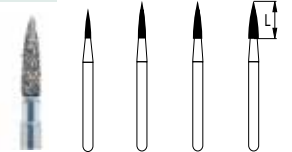

Diam./Size ø 1/10 mm	010	012	014	016
Lungh./Length in mm	4,0	5,0	5,0	5,0

Shank ISO REF ORDINE N°

□ FG 806 314 247 524 ... 860...M	010 ₁	012 ₁	014 ₁	016 ₁
■ FG 806 314 247 544 ... 860...SG			014 ₂	
■ FG 806 314 247 534 ... 860...G	010 ₂	012 ₂	014 ₂	016 ₂
■ FG 806 314 247 514 ... 860...F	010 ₂	012 ₂	014 ₂	016 ₂
■ FG 806 314 247 504 ... 860...SF	010 ₂	012 ₂	014 ₂	

*1-2-3- GRUPPO / GROUP

- M- ISO 524 (110-120 µm) Senza Anello/Without Ring • MEDIA / STANDARD
- SG- ISO 544 (180 µm) Anello Nero/Black Ring • SUPERGROSSA/SUPERCOARSE
- G- ISO 534 (135 µm) Anello Verde/Green Ring • GROSSA / COARSE
- F- ISO 514 (50 µm) Anello Rosso/Red Ring • FINE / FINE
- SF- ISO 504 (30 µm) Anello Giallo/Yellow Ring • SUPERFINE / SUPERFINE

861 (248)

3 Fiamma
Flame

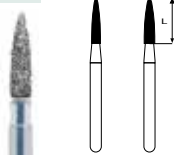

Diam./Size ø 1/10 mm 012 014

Lungh./Length in mm 6,0 6,0

Shank ISO REF ORDINE N°

 FG 806 314 248 524 ... **861...M** 012₁ 014₁

 FG 806 314 248 534 ... **861...G** 012₂ 014₂

 FG 806 314 248 514 ... **861...F** 012₂

 FG 806 314 248 504 ... **861...SF** 012₂ 014₂

 RA 806 204 248 524 ... **861...M-RA** 014₂

861SE (255)

3 Fiamma con punta non lavorante
Flame Safe End

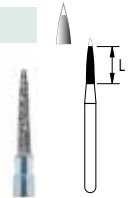

Diam./Size ø 1/10 mm 012

Lungh./Length in mm 6,0

Shank ISO REF ORDINE N°

 FG 806 314 255 524 ... **861SE...M** 012₃

862 (249)

3 Fiamma
Flame

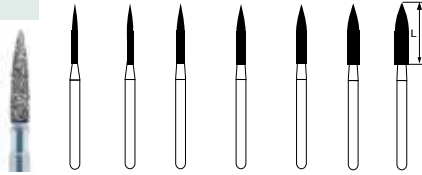

Diam./Size ø 1/10 mm 009 010 012 014 016 018 021

Lungh./Length in mm 8,0 8,0 8,0 8,0 8,0 8,0 8,0

Shank ISO REF ORDINE N°

 FG 806 314 249 524 ... **862...M** 009₂ 010₂ 012₂ 014₂ 016₂ 018₂ 021₂

 FG 806 314 249 544 ... **862...SG** 012₃ 014₃ 016₃ 018₃

 FG 806 314 249 534 ... **862...G** 010₃ 012₃ 014₃ 016₃ 018₃

 FG 806 314 249 514 ... **862...F** 009₃ 010₃ 012₃ 014₃ 016₃

 FG 806 314 249 504 ... **862...SF** 009₃ 010₃ 012₃ 014₃ 016₃

863SE (256)

3 Fiamma con punta non lavorante
Flame Safe End



Diam./Size ø 1/10 mm 012

Lungh./Length in mm 10,0

Shank ISO REF ORDINE N°

 FG 806 314 256 524 ... **863SE...M** 012₃

863 (250)

3 Fiamma
Flame

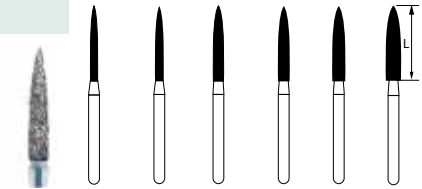

Diam./Size ø 1/10 mm 010 012 014 016 018 021

Lungh./Length in mm 10,0 10,0 10,0 10,0 10,0 10,0

Shank ISO REF ORDINE N°

 FG 806 314 250 524 ... **863...M** 010₂ 012₂ 014₂ 016₂ 018₂ 021₂

 FG 806 314 250 544 ... **863...SG** 012₃ 016₃ 018₃ 021₃

 FG 806 314 250 534 ... **863...G** 012₃ 014₃ 016₃ 018₃ 021₃

 FG 806 314 250 514 ... **863...F** 010₃ 012₃ 014₃ 016₃ 018₃

 FG 806 314 250 504 ... **863...SF** 010₃ 012₃ 014₃ 016₃

863L (252)

3

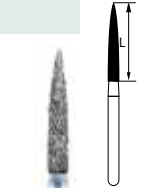

Diam./Size ø 1/10 mm 016

Lungh./Length in mm 10,5

Shank ISO REF ORDINE N°

 FG 806 314 252 524 ... **863L...M** 016₃

 FG 806 314 252 534 ... **863L...G** 016₃

*1-2-3: GRUPPO / GROUP

- M- ISO 524 (110-120 µm) Senza Anello/Without Ring • MEDIA / STANDARD
- SG- ISO 544 (180 µm) Anello Nero/Black Ring • SUPERGROSSA/SUPERCOARSE
- G- ISO 534 (135 µm) Anello Verde/Green Ring • GROSSA / COARSE
- F- ISO 514 (50 µm) Anello Rosso/Red Ring • FINE / FINE
- SF- ISO 504 (30 µm) Anello Giallo/Yellow Ring • SUPERFINE / SUPERFINE

864 (251)



Fiamma
Flame

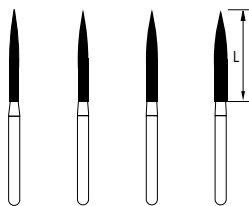

Diam./Size ø 1/10 mm 012 014 016 018

Lungh./Length in mm 12,0 12,0 12,0 12,0

Shank ISO REF ORDINE N°

FG 806 314 251 524 ... **864...M** 012₃ 014₃ 016₃ 018₃

FG 806 314 251 544 ... **864...SG** 016₃ 018₃

FG 806 314 251 534 ... **864...G** 014₃ 016₃ 018₃

FG 806 314 251 514 ... **864...F** 012₃ 014₃ 016₃

FG 806 314 251 504 ... **864...SF** 016₃

874 (534)



Cilindro a punta
Beveled End Cylinder

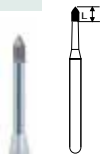

Diam./Size ø 1/10 mm 009

Lungh./Length in mm 2,0

Shank ISO REF ORDINE N°

FG 806 314 534 524 ... **874...M** 009

874K (536)



Curettagge
Torpedo tapered

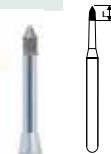

Diam./Size ø 1/10 mm 010

Lungh./Length in mm 2,0

Shank ISO REF ORDINE N°

FG 806 314 536 524 ... **874K...M** 010₃

875K (537)



Curettagge
Torpedo tapered



Diam./Size ø 1/10 mm 012

Lungh./Length in mm 3,0

Shank ISO REF ORDINE N°

FG 806 314 537 524 ... **875K...M** 012₃

FG 806 314 537 514 ... **875K...F** 012₃

875 (535)



Cilindro a punta
Modified Beveled Cylinder



Diam./Size ø 1/10 mm 009 010

Lungh./Length in mm 3,0 4,0

Shank ISO REF ORDINE N°

FG 806 314 535 524 ... **875...M** 009₃ 010₃

876 (287)



Cilindro a punta
Modified Beveled Cylinder



Diam./Size ø 1/10 mm 009

Lungh./Length in mm 5,0

Shank ISO REF ORDINE N°

FG 806 314 287 524 ... **876...M** 009₁

FG 806 314 287 514 ... **876...F** 009₁

876K (296)



Curettagge
Torpedo tapered



Diam./Size ø 1/10 mm 012

Lungh./Length in mm 5,0

Shank ISO REF ORDINE N°

FG 806 314 296 524 ... **876K...M** 012₁

*1-2-3: GRUPPO / GROUP

- M- ISO 524 (110-120 µm) Senza Anello/Without Ring • MEDIA / STANDARD
- SG- ISO 544 (180 µm) Anello Nero/Black Ring • SUPERGROSSA/SUPERCOARSE
- G- ISO 534 (135 µm) Anello Verde/Green Ring • GROSSA / COARSE
- F- ISO 514 (50 µm) Anello Rosso/Red Ring • FINE / FINE
- SF- ISO 504 (30 µm) Anello Giallo/Yellow Ring • SUPERFINE / SUPERFINE

877 (288)

Cilindro a punta
Modified Beveled Cylinder

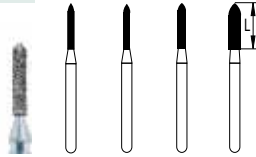

Diam./Size ø 1/10 mm 009 010 012 018

Lungh./Length in mm 6,0 6,0 6,0 6,0

Shank ISO REF ORDINE N°

FG 806 314 288 524 ... **877...M** 009₁ 010₁ 012₁

FG 806 314 288 534 ... **877...G** 012₂ 018₂

FG 806 314 288 514 ... **877...F** 010₂ 012₂

877K (297)

Curettege
Torpedo tapered

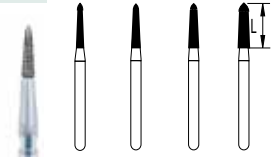

Diam./Size ø 1/10 mm 012 014 016 018

Lungh./Length in mm 6,0 6,0 6,0 6,0

Shank ISO REF ORDINE N°

FG 806 314 297 524 ... **877K...M** 012₁ 014₁ 016₁ 018₁

FG 806 314 297 544 ... **877K...SG** 014₂ 016₂ 018₂

FG 806 314 297 534 ... **877K...G** 012₂ 014₂ 016₂ 018₂

878 (289)

Cilindro a punta
Modified Beveled Cylinder

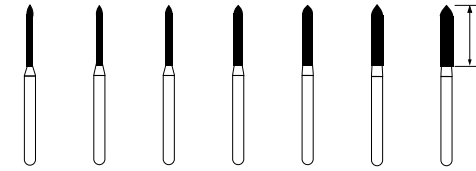

Diam./Size ø 1/10 mm 008 009 010 012 014 016 018

Lungh./Length in mm 8,0 8,0 8,0 8,0 8,0 8,0 8,0

Shank ISO REF ORDINE N°

FG 806 314 289 524 ... **878...M** 008₂ 009₂ 010₂ 012₂ 014₂ 016₂ 018₂

FG 806 314 289 544 ... **878...SG** 012₃ 014₃ 016₃

FG 806 314 289 534 ... **878...G** 010₃ 012₃ 014₃ 016₃ 018₃

FG 806 314 289 514 ... **878...F** 008₃ 009₃ 010₃ 012₃ 014₃ 016₃

FG 806 314 289 504 ... **878...SF** 010₃ 012₃ 014₃

878K (298)

Curettege
Torpedo tapered

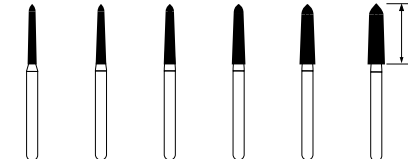

Diam./Size ø 1/10 mm 012 014 016 018 021 023

Lungh./Length in mm 8,0 8,0 8,0 8,0 8,0 8,0

Shank ISO REF ORDINE N°

FG 806 314 298 524 ... **878K...M** 012₂ 014₂ 016₂ 018₂ 021₂

FG 806 314 298 544 ... **878K...SG** 012₃ 014₃ 016₃ 018₃ 021₃ 023₃

FG 806 314 298 534 ... **878K...G** 012₃ 014₃ 016₃ 018₃ 021₃ 023₃

FG 806 314 298 514 ... **878K...F** 012₃ 014₃ 016₃ 018₃ 021₃

FG 806 314 298 504 ... **878K...SF** 012₃

*1-2-3: GRUPPO / GROUP

- M- ISO 524 (110-120 µm) Senza Anello/Without Ring • MEDIA / STANDARD
- SG- ISO 544 (180 µm) Anello Nero/Black Ring • SUPERGROSSA/SUPERCOARSE
- G- ISO 534 (135 µm) Anello Verde/Green Ring • GROSSA / COARSE
- F- ISO 514 (50 µm) Anello Rosso/Red Ring • FINE / FINE
- SF- ISO 504 (30 µm) Anello Giallo/Yellow Ring • SUPERFINE / SUPERFINE

879 (290)

3 Cilindro a punta
Cylindrical Torpedo

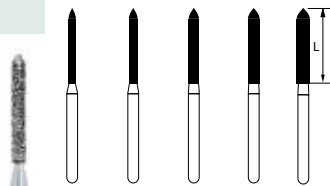

Diam./Size ø 1/10 mm	010	012	014	016	018
Lungh./Length in mm	10,0	10,0	10,0	10,0	10,0

Shank	ISO	REF	ORDINE N°					
 FG	806 314 290 524 ...	879...M		010 ₂	012 ₂	014 ₂	016 ₂	018 ₂
 FG	806 314 290 544 ...	879...SG			012 ₃	014 ₃	016 ₃	018 ₃
 FG	806 314 290 534 ...	879...G		010 ₃	012 ₃	014 ₃	016 ₃	018 ₃
 FG	806 314 290 514 ...	879...F		010 ₃	012 ₃	014 ₃	016 ₃	018 ₃
 FG	806 314 290 504 ...	879...SF			012 ₃	014 ₃	016 ₃	

879L (291)

3 Cilindro a punta lungo
Torpedo long

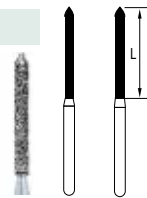

Diam./Size ø 1/10 mm	012	014
Lungh./Length in mm	12,0	12,0

Shank	ISO	REF	ORDINE N°		
 FG	806 314 291 524 ...	879L...M		012 ₃	014 ₃
 FG	806 314 291 544 ...	879L...SG		012 ₃	014 ₃
 FG	806 314 291 534 ...	879L...G		012 ₃	014 ₃
 FG	806 314 291 514 ...	879L...F		012 ₃	014 ₃

879K (299)

3 Curettage
Torpedo tapered

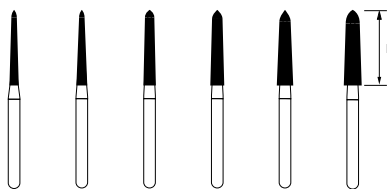

Diam./Size ø 1/10 mm	012	014	016	018	021	023
Lungh./Length in mm	10,0	10,0	10,0	10,0	10,0	10,0

Shank	ISO	REF	ORDINE N°						
 FG	806 314 299 524 ...	879K...M		012 ₂	014 ₂	016 ₂	018 ₂	021 ₂	023 ₂
 FG	806 314 299 544 ...	879K...SG		012 ₃	014 ₃	016 ₃	018 ₃	021 ₃	
 FG	806 314 299 534 ...	879K...G		012 ₃	014 ₃	016 ₃	018 ₃	021 ₃	023 ₃
 FG	806 314 299 514 ...	879K...F		012 ₃	014 ₃	016 ₃	018 ₃		
 FG	806 314 299 504 ...	879K...SF					014 ₃		

880 (140)

3 Cilindro a punta arrotondata
Round End Cylinder

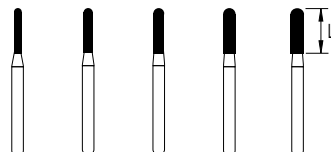

Diam./Size ø 1/10 mm	010	012	014	016	018
Lungh./Length in mm	6,0	6,0	6,0	6,0	6,0

Shank	ISO	REF	ORDINE N°					
 FG	806 314 140 524 ...	880...M		010 ₁	012 ₁	014 ₁	016 ₁	018 ₃
 FG	806 314 140 544 ...	880...SG				014 ₂	016 ₃	
 FG	806 314 140 534 ...	880...G		012 ₂	014 ₂	016 ₃		018 ₃
 FG	806 314 140 514 ...	880...F			012 ₂	014 ₂	016 ₃	
 FG	806 314 140 504 ...	880...SF			012 ₂			

012 ₂	014 ₂	016 ₃	016 ₃
------------------	------------------	------------------	------------------

*1-2-3: GRUPPO / GROUP

- -M- ISO 524 (110-120 µm) Senza Anello/Without Ring • MEDIA / STANDARD
- -SG- ISO 544 (180 µm) Anello Nero/Black Ring • SUPERGROSSA/SUPERCOARSE
- -G- ISO 534 (135 µm) Anello Verde/Green Ring • GROSSA / COARSE
- -F- ISO 514 (50 µm) Anello Rosso/Red Ring • FINE / FINE
- -SF- ISO 504 (30 µm) Anello Giallo/Yellow Ring • SUPERFINE / SUPERFINE

881 (141)

 Cilindro a punta arrotondata
Round End Cylinder

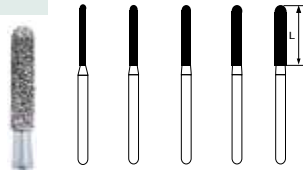

Diam./Size ø 1/10 mm 010 012 014 016 018

Lungh./Length in mm 8,0 8,0 8,0 8,0 8,0

Shank	ISO	REF	ORDINE N°	
■	FG	806 314 141 524 ...	881...M	010 ₂ 012 ₂ 014 ₂ 016 ₂ 018 ₂
■	FG	806 314 141 544 ...	881...SG	014 ₃ 016 ₃ 018 ₃
■	FG	806 314 141 534 ...	881...G	010 ₃ 012 ₃ 014 ₃ 016 ₃ 018 ₃
■	FG	806 314 141 514 ...	881...F	010 ₃ 012 ₃ 014 ₃ 016 ₃ 018 ₃
■	FG	806 314 141 504 ...	881...SF	012 ₃ 014 ₃

881KS (146)

 Cilindro KS
KS Cylinder

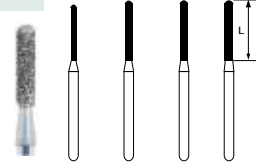

Diam./Size ø 1/10 mm 012 014 016 018

Lungh./Length in mm 7,0 8,0 8,0 8,0

Shank	ISO	REF	ORDINE N°	
■	FG	806 314 146 544 ...	881KS...SG	012 ₂ 014 ₂ 016 ₂ 018 ₂

882 (142)

 Cilindro a punta arrotondata
Round End Cylinder

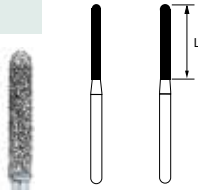

Diam./Size ø 1/10 mm 012 014

Lungh./Length in mm 10,0 10,0

Shank	ISO	REF	ORDINE N°	
■	FG	806 314 142 524 ...	882...M	012 ₂ 014 ₂
■	FG	806 314 142 544 ...	882...SG	014 ₃
■	FG	806 314 142 534 ...	882...G	012 ₃ 014 ₃
■	FG	806 314 142 514 ...	882...F	012 ₃ 014 ₃
■	FG	806 314 142 504 ...	882...SF	012 ₃

883 (539)

 Fiamma
aFlame



Diam./Size ø 1/10 mm 010

Lungh./Length in mm 3,0

Shank	ISO	REF	ORDINE N°	
■	FG	806 314 539 524 ...	883...M	010 ₁
■	FG	806 314 539 534 ...	883...G	010 ₂

884 (129)

 Cilindro a punta
Beveled Cylinder

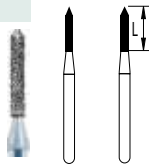

Diam./Size ø 1/10 mm 010 012

Lungh./Length in mm 6,0 6,0

Shank	ISO	REF	ORDINE N°	
■	FG	806 314 129 524 ...	884...M	010 ₁ 012 ₁
■	FG	806 314 291 534 ...	884...G	012 ₂
■	FG	806 314 291 514 ...	884...F	012 ₂

885 (130)

 Cilindro a punta
Beveled Cylinder

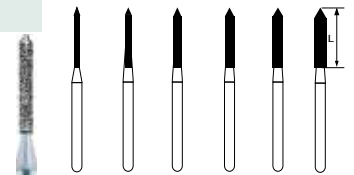

Diam./Size ø 1/10 mm 008 010 012 014 016 018

Lungh./Length in mm 8,0 8,0 8,0 8,0 8,0



Shank	ISO	REF	ORDINE N°	
■	FG	806 314 130 524 ...	885...M	008 ₂ 010 ₂ 012 ₂ 014 ₂ 016 ₂
■	FG	806 314 130 544 ...	885...SG	012 ₃ 014 ₃ 018 ₃
■	FG	806 314 130 534 ...	885...G	012 ₃ 014 ₃
■	FG	806 314 130 514 ...	885...F	010 ₃ 012 ₃ 014 ₃

*1-2-3: GRUPPO / GROUP

- -M- ISO 524 (110-120 µm) Senza Anello/Without Ring • MEDIA / STANDARD
- -SG- ISO 544 (180 µm) Anello Nero/Black Ring • SUPERGROSSA/SUPERCOARSE
- -G- ISO 534 (135 µm) Anello Verde/Green Ring • GROSSA / COARSE
- -F- ISO 514 (50 µm) Anello Rosso/Red Ring • FINE / FINE
- -SF- ISO 504 (30 µm) Anello Giallo/Yellow Ring • SUPERFINE / SUPERFINE

886 (131)

 **Cilindro a punta**
Beveled Cylinder

Diam./Size ø 1/10 mm



Lungh./Length in mm

Shank	ISO	REF	ORDINE N°
FG	806 314 131 524 ...	886...M	010 ₂ 012 ₂ 014 ₂ 016 ₂ 018 ₂
FG	806 314 131 544 ...	886...SG	012 ₃ 014 ₃ 016 ₃
FG	806 314 131 534 ...	886...G	012 ₃ 014 ₃ 016 ₃ 018 ₃
FG	806 314 131 514 ...	886...F	010 ₃ 012 ₃ 014 ₃ 016 ₃ 018 ₃
FG	806 314 131 504 ...	886...SF	012 ₃

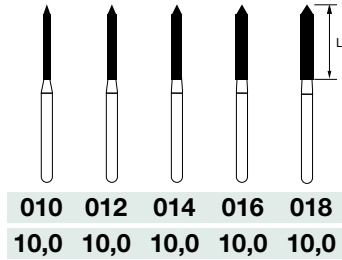

888 (496)

 **Fiamma**
Flame

Diam./Size ø 1/10 mm



Lungh./Length in mm

Shank	ISO	REF	ORDINE N°
FG	806 314 496 524 ...	888...M	012 ₂
FG	806 314 496 534 ...	888...G	012 ₃
FG	806 314 496 514 ...	888...F	012 ₃
FG	806 314 496 504 ...	888...SF	012 ₃

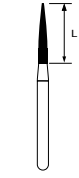

889 (540)

 **Fiamma**
Flame

Diam./Size ø 1/10 mm



Lungh./Length in mm

Shank	ISO	REF	ORDINE N°
FG	806 314 540 524 ...	889...M	009 ₁ 010 ₁
FG	806 314 540 544 ...	889...SG	010 ₂
FG	806 314 540 534 ...	889...G	009 ₂ 010 ₂
FG	806 314 540 514 ...	889...F	009 ₂ 010 ₂
FG	806 314 540 504 ...	889...SF	009 ₂ 010 ₂

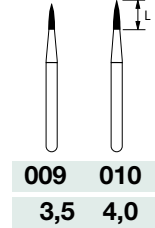

898 (213)

 **Fiamma**
Flame

Diam./Size ø 1/10 mm



Lungh./Length in mm

Shank	ISO	REF	ORDINE N°
FG	806 314 213 524 ...	898...M	016 ₂
FG	806 314 213 534 ...	898...G	016 ₃
FG	806 314 213 514 ...	898...F	016 ₃

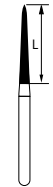

899 (033)

 **Football**
Pointed Bud

Diam./Size ø 1/10 mm

Lungh./Length in mm

Shank	ISO	REF	ORDINE N°
FG	806 314 033 524 ...	899...M	021 ₃ 027 ₃ 031 ₃
FG	806 314 033 544 ...	899...SG	021 ₃ 027 ₃ 031 ₃
FG	806 314 033 534 ...	899...G	021 ₃ 027 ₃ 031 ₃
FG	806 314 033 514 ...	899...F	021 ₃ 027 ₃
FG	806 314 033 504 ...	899...SF	027 ₃

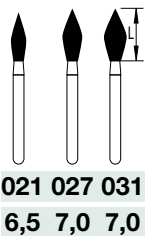

*1-2-3: GRUPPO / GROUP

Frese diamantate

DENTAL MARKET Diamond burs
design and manufacturing of dental articles

- -M- ISO 524 (110-120 µm) Senza Anello/Without Ring • MEDIA / STANDARD
- -SG- ISO 544 (180 µm) Anello Nero/Black Ring • SUPERGROSSA/SUPERCOARSE
- -G- ISO 534 (135 µm) Anello Verde/Green Ring • GROSSA / COARSE
- -F- ISO 514 (50 µm) Anello Rosso/Red Ring • FINE / FINE
- -SF- ISO 504 (30 µm) Anello Giallo/Yellow Ring • SUPERFINE / SUPERFINE

3,5 3,5 4,5 5,0

368 (257)

3 Football Pointed Bud

Diam./Size ø 1/10 mm	010	012	014	016	018	023
Lungh./Length in mm	3,5	3,5	3,5	3,5	4,5	5,0
Shank	ISO	REF	ORDINE N°			
FG 806 314 257 524 ...	368...M	010 ₁	012 ₁	014 ₁	016 ₁	018 ₁ 023 ₁
FG 806 314 257 544 ...	368...SG	012 ₂	014 ₂	016 ₂	018 ₂	023 ₂
FG 806 314 257 534 ...	368...G	012 ₂	014 ₂	016 ₂	018 ₂	023 ₂
FG 806 314 257 514 ...	368...F	010 ₂	012 ₂	014 ₂	016 ₂	018 ₂ 023 ₂
FG 806 314 257 504 ...	368...SF	010 ₂	012 ₂	014 ₂	016 ₂	018 ₂ 023 ₂

369 (263)

3 Football Bud

Diam./Size ø 1/10 mm	025			
Lungh./Length in mm	5,5			
Shank	ISO	REF	ORDINE N°	
FG 806 314 263 524 ...	369...M	025 ₃		
FG 806 314 263 534 ...	369...G	025 ₃		
FG 806 314 263 514 ...	369...F	025 ₃		
FG 806 314 263 504 ...	369...SF	025 ₃		

370 (507)

3 Per modellare le superfici
For contouring the surface

Diam./Siz ø 1/10 mm	023			
Lungh./Length in mm	6,0			
Shank	ISO	REF	ORDINE N°	
FG 806 314 507 534 ...	370...G	023 ₃		

379 (277)

3 Ovale
Egg Shape - Football

Diam./Size ø 1/10 mm	012	014	016	018	023	029
Lungh./Length in mm	3,0	3,0	3,5	3,5	4,5	4,5
Shank	ISO	REF	ORDINE N°			
FG 806 314 277 524 ...	379...M	012 ₁	014 ₁	016 ₁	018 ₁	023 ₂ 029 ₂
FG 806 314 277 544 ...	379...SG	016 ₂ 018 ₂ 023 ₂ 029 ₂				
FG 806 314 277 534 ...	379...G	012 ₂	014 ₂	016 ₂	018 ₂	023 ₂ 029 ₂
FG 806 314 277 514 ...	379...F	012 ₂	014 ₂	016 ₂	018 ₂	023 ₂ 029 ₂
FG 806 314 277 504 ...	379...SF	012 ₂	014 ₂	016 ₂	018 ₂	023 ₂ 029 ₂

390 (274)

3 Granata
Grenade





Diam./Size ø 1/10 mm	016			
Lungh./Length in mm	3,5			
Shank	ISO	REF	ORDINE N°	
FG 806 314 274 524 ...	390...M	016 ₂		
FG 806 314 274 514 ...	390...F	016 ₂		
FG 806 314 274 504 ...	390...SF	016 ₂		

392 (465)

3 Interrossimale
Interproximal

Diam./Size ø 1/10 mm	016			
Lungh./Length in mm	5,0			
Shank	ISO	REF	ORDINE N°	
FG 806 314 465 524 ...	392...M	016 ₂		
FG 806 314 465 514 ...	392...F	016 ₂		
FG 806 314 465 504 ...	392...SF	016 ₂		

*1-2-3: GRUPPO / GROUP

-  -M- ISO 524 (110-120 µm) Senza Anello/Without Ring • MEDIA / STANDARD
 -SG- ISO 544 (180 µm) Anello Nero/Black Ring • SUPERGROSSA/SUPERCOARSE
 -G- ISO 534 (135 µm) Anello Verde/Green Ring • GROSSA / COARSE
 -F- ISO 514 (50 µm) Anello Rosso/Red Ring • FINE / FINE
 -SF- ISO 504 (30 µm) Anello Giallo/Yellow Ring • SUPERFINE / SUPERFINE

392a (465)

3

Interprossimale
Interproximal



Diam./Size ø 1/10 mm

016

Lungh./Length in mm

3,5

 Shank ISO REF ORDINE N°

 FG 806 314 465 524 ... **392A...M** 016₂
 FG 806 314 465 514 ... **392A...F** 016₂

909 (068)

3

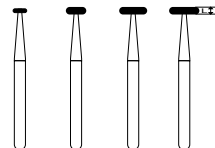
Ruota
Round Wheel

Diam./Size ø 1/10 mm

018 027 037 040

Lungh./Length in mm

0,5 1,0 1,0 1,0

 Shank ISO REF ORDINE N°

 FG 806 314 068 524 ... **909...M** 018₃ 027₃ 037₃ 040₃
 FG 806 314 068 544 ... **909...SG** 037₃ 040₃
 FG 806 314 068 534 ... **909...G** 037₃ 040₃

651 (510)

3

Reducer





Diam./Size ø 1/10 mm

018

Lungh./Length in mm

6,0

 Shank ISO REF ORDINE N°

 FG 806 314 510 524 ... **651...M** 018₃
 FG 806 314 510 544 ... **651...SG** 018₃
 FG 806 314 510 534 ... **651...G** 018₃

652 (510)

3

Reducer





Diam./Size/Taille/Größe ø 1/10 mm

018

Lungh./Length/Longueur/Länge in mm

8,0

 Shank ISO REF ORDINE N°

 FG 806 314 510 524 ... **652...M** 018₃
 FG 806 314 510 544 ... **652...SG** 018₃
 FG 806 314 510 534 ... **652...G** 018₃

653 (510)

3

Reducer





Diam./Size ø 1/10 mm

018

Lungh./Length in mm

10,0

 Shank ISO REF ORDINE N°

 FG 806 314 510 524 ... **653...M** 018₃
 FG 806 314 510 544 ... **653...SG** 018₃
 FG 806 314 510 534 ... **653...G** 018₃

654 (516)

3

Reducer





Diam./Size ø 1/10 mm

018

Lungh./Length in mm

6,0

 Shank ISO REF ORDINE N°

 FG 806 314 516 524 ... **654...M** 018₃
 FG 806 314 516 544 ... **654...SG** 018₃
 FG 806 314 516 534 ... **654...G** 018₃

*1-2-3: GRUPPO / GROUP

Frese diamantate

DENTAL MARKET Diamond burs
 design and manufacturing of dental articles

- -M- ISO 524 (110-120 µm) Senza Anello/Without Ring • MEDIA / STANDARD
- -SG- ISO 544 (180 µm) Anello Nero/Black Ring • SUPERGROSSA/SUPERCOARSE
- -G- ISO 534 (135 µm) Anello Verde/Green Ring • GROSSA / COARSE
- -F- ISO 514 (50 µm) Anello Rosso/Red Ring • FINE / FINE
- -SF- ISO 504 (30 µm) Anello Giallo/Yellow Ring • SUPERFINE / SUPERFINE

655 (516)

 **Reducer**



Diam./Size ø 1/10 mm		018
Lungh./Length in mm		8,0
 Shank	ISO	REF ORDINE N°
□ FG	806 314 516 524 ...	655...M 018 ₃
■ FG	806 314 516 544 ...	655...SG 018 ₃
■ FG	806 314 516 534 ...	655...G 018 ₃

656 (516)

 **Reducer**

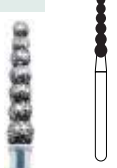

Diam./Size ø 1/10 mm		018
Lungh./Length in mm		10,0
 Shank	ISO	REF ORDINE N°
□ FG	806 314 516 524 ...	656...M 018 ₃
■ FG	806 314 516 544 ...	656...SG 018 ₃
■ FG	806 314 516 534 ...	656...G 018 ₃

BAMBINO

 **Bambino Baby**



Diam./Size ø 1/10 mm	008	010	010	010	009	012	008	008	008
Lungh./Length in mm	0,8	1,0	0,8	1,0	3,5	6,0	3,5	2,0	3,5
ORDER NO.- BAMBINO (M)... ..	001.0082	001.0102	010.0082	010.0102	108.0092	171.0122	295.0082	274.0082	138.0082

850 (199) TURBO

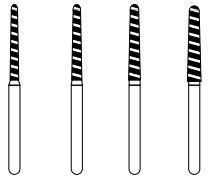

 **Cono arrotondato Round end taper**





Diam./Size ø 1/10 mm		012	014	016	018
Lungh./Length in mm		10,0	10,0	10,0	10,0
 Shank	ISO	REF		ORDINE N°	
□ FG	806 314 199 524 ...	850...M-T	014 ₃	016 ₃	018 ₃
■ FG	806 314 199 544 ...	850...SG-T	014 ₃	016 ₃	018 ₃
■ FG	806 314 199 534 ...	850...G-T	012 ₃	014 ₃	016 ₃ 018 ₃

856 (198) TURBO

 **Cono arrotondato Round end taper**

Diam./Size ø 1/10 mm		012
Lungh./Length in mm		8,0
 Shank	ISO	REF ORDINE N°
■ FG	806 314 198 544 ...	856...SG-T 012 ₃
■ FG	806 314 198 534 ...	856...G-T 012 ₃

- -M- ISO 524 (110-120 µm) Senza Anello/Without Ring • MEDIA / STANDARD
- -SG- ISO 544 (180 µm) Anello Nero/Black Ring • SUPERGROSSA/SUPERCOARSE
- -G- ISO 534 (135 µm) Anello Verde/Green Ring • GROSSA / COARSE
- -F- ISO 514 (50 µm) Anello Rosso/Red Ring • FINE / FINE
- -SF- ISO 504 (30 µm) Anello Giallo/Yellow Ring • SUPERFINE / SUPERFINE

859 (166) TURBO



Cono
Needle

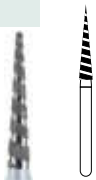

Diam./Size ø 1/10 mm 014

Lungh./Length in mm 10,0

Shank ISO REF ORDINE N°

FG 806 314 166 524 ... 859...M-T 018

FG 806 314 166 534 ... 859...G-T 018

863 (250) TURBO



Fiamma
Flame

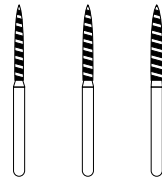

Diam./Size ø 1/10 mm 012 014 016

Lungh./Length in mm 10,0 10,0 10,0

Shank ISO REF ORDINE N°

FG 806 314 250 524 ... 363...M-T 014₃

FG 806 314 250 544 ... 363...SG-T 012₃ 014₃ 016₃

FG 806 314 250 534 ... 363...G-T 014₃

879 (290) TURBO



Cilindro a punta
Beveled cylinder

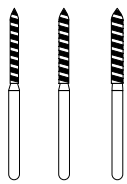

Diam./Size ø 1/10 mm 012 014 016

Lungh./Length in mm 10,0 10,0 10,0

Shank ISO REF ORDINE N°

FG 806 314 290 524 ... 879...M-T 012₃ 014₃ 016₃

FG 806 314 290 544 ... 879...SG-T 012₃ 014₃ 016₃

FG 806 314 290 534 ... 879...G-T 012₃ 014₃ 016₃

879K (299) TURBO



Cono a punta
Curretage

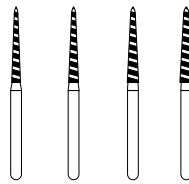

Diam./Size ø 1/10 mm 012 014 016 018

Lungh./Length in mm 10,0 10,0 10,0 10,0

Shank ISO REF ORDINE N°

FG 806 314 299 524 ... 879K...M-T 016₃

FG 806 314 299 544 ... 879K...SG-T 018₃ 014₃ 016₃ 018₃

FG 806 314 299 534 ... 879K...G-T 012₃ 014₃ 016₃ 018₃

882 (142) TURBO



Cilindro arrotondato
Round end cylinder

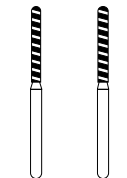

Diam./Size ø 1/10 mm 012 014

Lungh./Length/Longueur/Länge in mm 10,0 10,0

Shank ISO REF ORDINE N°

FG 806 314 142 524 ... 882...M-T 012₃

FG 806 314 142 534 ... 882...G-T 012₃ 014₃

886 (131) TURBO



Cilindro a punta
Beveled cylinder

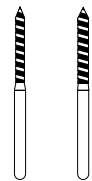

Diam./Size ø 1/10 mm 012 014

Lungh./Length in mm 10,0 10,0

Shank ISO REF ORDINE N°

FG 806 314 131 524 ... 886...M-T 012₃ 014₃

FG 806 314 131 544 ... 886...SG-T 012₃ 014₃

FG 806 314 131 534 ... 886...G-T 012₃ 014₃

*1-2-3: GRUPPO / GROUP

DENTAL MARKET

design and manufacturing of dental articles

Dental Market srl

Sede Legale: Via Sarzanese, 1252 - 55054 Bozzano Massarosa (LU) Italy

Sede Operativa: Via S. Pieretto, 24/26 - 55060 Guamo (LU) Italy

Tel. +39 0583 1900385 - Fax +39 0583 1900386

www.dentalmarket.biz - info@dentalmarket.biz



MADE IN ITALY

